

SPARK PLUGS

Catalogue: Issue 4.2



ACDelco



SPARK PLUG

warranty

ACDelco Automotive Parts are warranted throughout Australia against faulty workmanship and materials for a period of 1 year or 20,000km (whichever comes first) from the purchase date.

If an ACDelco Automotive Part is defective (other than for the warranty exclusions specified below) during that period, we will replace or repair it at our cost. To make a claim please return the part to the place of purchase, or your nearest authorised ACDelco stockist.

This voluntary warranty is given by GM Holden Ltd (trading as ACDelco) of 191 Salmon Street, Port Melbourne, Victoria, Australia. For customer assistance, please call us toll free on 1800 ACDelco (1800 223 352).

WARRANTY CONDITIONS

This warranty does not cover:

- Normal wear and tear.
- Labour for removal, and replacement of the unit, from the vehicle unless prior written approval has been obtained from ACDelco.
- Parts which have been subjected to deliberate abuse.
- Conditions resulting from abnormal wear, negligence, alterations or accidents.
- Incorrect fitment.
- Parts used in an incorrect application or parts that are not used for their intended purpose.

Our goods come with guarantees that cannot be excluded under the Australian Consumer Law. You are entitled to a replacement or refund for a major failure and for compensation for any other reasonably foreseeable loss or damage. You are also entitled to have the goods repaired or replaced if the goods fail to be of acceptable quality and the failure does not amount to a major failure. The benefits under this warranty are in addition to other rights and remedies you may have at law.

WARRANTY QUESTIONS AND ANSWERS

Q. Will using ACDelco parts void my new vehicle warranty offered by the vehicle manufacturer?

A. As ACDelco products are made to exacting standards, their use should not affect your vehicle warranty provided the correct part is used and is correctly fitted. However, if the use of a correctly installed ACDelco part causes a component failure in your vehicle that is not covered by the manufacturer, ACDelco will, subject to the above Warranty Conditions, cover the cost of repair.

Q. The manufacturer of my vehicle has rejected a warranty claim as they are claiming the failure was caused by a faulty ACDelco part, will ACDelco cover the repairs?

A. In the unlikely event that it is determined that an ACDelco part has lead to a component failure in your vehicle ACDelco will cover the cost of the repair, subject to the above Warranty Conditions.

Q. How do I make a warranty claim?

A. In the first instance contact the place of purchase. Should you require further assistance contact ACDelco on 1800 223 352.

COPYRIGHT STATEMENT

No part of this publication may be reproduced, stored in any retrieval system or transmitted in any form or by any means, including but not limited to electronic, mechanical, photocopying, recording or otherwise, without the prior written permission of ACDelco. This includes all texts, illustrations, tables and charts.



SPARK PLUG CATALOGUE

issue 4.2 - contents

WARRANTY

ACDelco Spark Plugs Warranty	2
------------------------------	---

PRODUCT INFORMATION

About ACDelco Regular Spark Plugs	4
About ACDelco Platinum (Rapidfire®) Spark Plugs	5
About ACDelco Double Platinum Spark Plugs	6
About ACDelco Double Platinum Finewire Spark Plugs	7
Workshop Guide - Selection & Installation Guidelines	8

APPLICATION LIST

ACDelco Spark Plugs by Vehicle Make and Model	10
---	----

OTHER REFERENCES

Spark Plug Abbreviations	86
Spark Plug Specifications ACDelco Regular Spark Plugs	87
Spark Plug Specifications ACDelco Platinum (Rapidfire®) Spark Plugs	88
Spark Plug Specifications ACDelco Double Platinum Spark Plugs	89
Spark Plug Specifications ACDelco Double Platinum Finewire Spark Plugs	90
Spark Plug Specifications Illustration	91
Spark Plug Specifications Metric / Imperial Gap Conversion Table	91
ACDelco Online Product Catalogue	92
Notes	93



ABOUT ACDELCO

regular spark plugs

ACDelco REGULAR SPARK PLUGS

With coverage for most older vehicles on the road today and robust design, ACDelco Regular Spark Plugs are an economical choice for solid performance.

Features and Benefits

- Has a copper-core center electrode that helps provide improved heat transfer from the tip, giving you the reliability you're looking for while providing better performance in most operating conditions*
- The copper-core center electrode allows for a longer insulator tip length for a given heat range, which helps prevent low-speed carbon fouling
- Precisely engineered and manufactured to provide everyday reliability and efficient performance
- The nickel-chrome alloy on the ground electrode and center electrode sheathing resists wear from spark erosion and the corrosive environment of the combustion chamber

* When compared to non copper core spark plugs





ABOUT ACDELCO platinum (rapidfire®) spark plugs

ACDelco PLATINUM (RAPIDFIRE®) SPARK PLUGS

Designed for today's most popular autos, ACDelco's Rapidfire® Platinum Spark Plug fits engines using regular plugs, as well as newer vehicles requiring platinum performance.

Features and Benefits

- Ribless insulator that helps to improve the plug-to-boot seal
- Tapered center wire electrode with a platinum pad reduces the firing diameter and helps improve the firing efficiency by concentrating and directing energy needed to fire the plug with less voltage*
- Reduced sparking voltage and greater corrosion protection*
- Longer life and improved efficiency*

* When compared to regular spark plugs





ABOUT ACDELCO

double platinum spark plugs

ACDelco DOUBLE PLATINUM SPARK PLUGS

An ideal plug for vehicles requiring platinum performance or older vehicles calling for regular plugs, ACDelco's Double Platinum Spark Plugs can give up to 100,000 kms# of service in some applications.

Maintenance needs vary with different uses and conditions. See Owner's Manual for more information.

Features and Benefits

- Dual platinum tip for improved resistance to spark erosion and corrosive combustion chamber environment*
- Internal glass resistor helps reduce radio frequency interference, meters spark plug energy to help provide long electrode life and seals against compression leakage
- Designed with a corrosion-resistant shell
- Spark gap remains virtually unchanged during the life of the plug

* When compared to regular spark plugs





ABOUT ACDELCO

double platinum finewire spark plugs

ACDelco DOUBLE PLATINUM FINEWIRE SPARK PLUGS

Designed to last up to 100,000 Kms# in most applications, ACDelco Double Platinum Finewire Plugs are the ideal replacement for today's newer vehicles.

Maintenance needs vary with different uses and conditions. See Owner's Manual for more information.

Features and Benefits

- Improved cold-starting and acceleration characteristics*
- Provides a more focused ignition for better overall ignitability*
- Reduced ignition system voltage demands saves wear and tear*
- Spark gap remains virtually unchanged during the life of the plug
- Suitable for newer vehicle applications using Finewire style plugs

** When compared to regular spark plugs*





WORKSHOP GUIDE

selection & installation guidelines

SELECTION PROCEDURE

1. Check the application section in this catalogue for the recommended spark plug.
2. Check condition of old spark plugs and driving conditions of application and adjust heat rating if appropriate.

To function correctly, spark plugs need to operate hot enough to burn off deposits, and remain below pre-ignition temperature.

INSTALLATION GUIDE

Replacing spark plugs may seem like a simple job, but proper procedures must be followed to ensure the best results. While you should always use the vehicle manufacturer's service procedures, which may include removal of certain engine components to access the spark plugs, here is a basic step by step guide:

1. Be sure that the engine is cool before beginning.
2. Carefully remove the spark-plug boots. Grasp the boot, twist it about a quarter turn to break the seal, and then lift it straight off. If the boot does not break free easily, use a spark-plug boot puller. As you remove the boots and ignition wires, number them using tape and a marker.
3. Clean the area around the spark plugs using a blast of compressed air, or by blowing through a soda straw. This prevents debris from falling into the combustion chamber when the old spark plugs are removed.
4. Loosen each spark plug using the correct hex-head socket wrench.
5. Remove the spark plugs and line them up in cylinder order. Inspect the spark plugs to identify any engine problems that may need attention.
6. Gap the new ACDelco spark plugs as recommended by the vehicle manufacturer. Use a rounded feeler gauge or a specific gapping tool to measure the gap between the centre electrode and side electrode. The gauge should pass through the gap snugly but easily. If too loose or too tight, adjust the gap as needed.
7. Screw the new spark plugs in by hand until just finger tight. If it is difficult to reach the spark plug socket, use a length of rubber hose to extend your reach.
8. Tighten the spark plugs using a torque wrench and following the vehicle manufacturer's recommendations. If you do not have a torque wrench, refer to the section on installing Spark Plugs without a torque wrench.
9. Before replacing the ignition wires and spark-plug boots, check them for any cracks or brittleness, or obvious signs of corrosion or wear. Replace the entire set if you detect any of the above defects.
10. Place a small amount of dielectric grease inside the spark-plug boot where it connects to the spark-plug barrel. This will help ensure a tight, moisture resistant seal and help resist flashover.
11. Replace the spark-plug wires in the correct order, following your marks. Make sure that the ignition wires are routed correctly and will not come into contact with hot engine components.
12. Start the engine. If the engine misfires or idles badly, shut it off and double-check that the ignition wires are not crossed or connected poorly. Check the firing order and all the connections carefully.

Note #1: Always replace spark plugs as a complete set. This is especially important with computer-controlled ignition systems.

Note #2: It is very important to properly tighten all of the spark plugs. Too little torque can cause the spark plug to leak combustion gases. Over-torquing the spark plug can damage both the plug and the threads in the cylinder head.

Note #3: Do not use any grease or lubricant on the spark plug threads since this may result in over-torquing the spark plugs, and could lead to engine damage.

WORKSHOP GUIDE

selection & installation guidelines

INSTALLING SPARK PLUGS WITHOUT A TORQUE WRENCH

It is always best to use a torque wrench to install spark plugs. If a torque wrench is not available, however, you may use this chart as a guide. (Note: These suggestions are for spark plugs with new gaskets.)

Spark Plug Thread / Seat	Tightening Procedure
14mm and 18mm tapered seat	Tighten 1/16 turn after finger tight
14mm and 18mm gasket seat	Tighten 1/2 turn past finger tight
12mm gasket seat	Tighten 3/8 turns past finger tight
10mm gasket seat	Tighten 1/4 turn past finger tight

1. **Finger Tight**



2. **1/16 Turn**

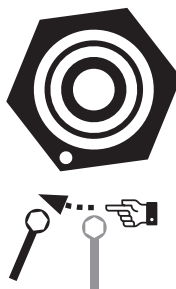

3. **1/4 Turn**

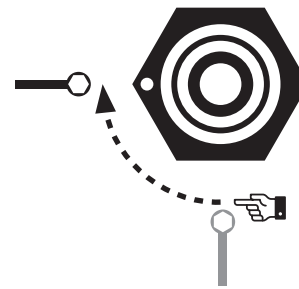

4. **3/8 Turn**

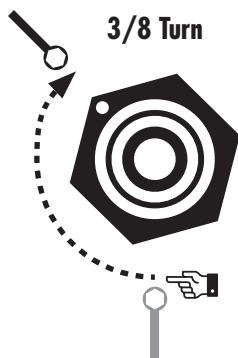

5. **1/2 Turn**



SPARK PLUG

application list

Information in this application listing section has been compiled from data published from Original Equipment Manufacturers and other parties. This data may change from time to time and ACDelco is unable to warrant the accuracy of this data and does not accept responsibility for loss or damage of any kind caused as a result of such data being inaccurate.

MAKE	MODEL	SERIES / BADGE	FROM	TO	CYLS	CAPACITY	ENGINE	ADDITIONAL INFORMATION	REGULAR	PLATINUM (RAPIDFIRE®)	DOUBLE PLATINUM	GAP (MM)#
ALFA ROMEO												
Alfa Romeo	33		06/83	1989	4	1.3L	AR30168		R42XLS	AC4	41804	0.8
Alfa Romeo	33		06/83	1989	4	1.5L	AR30504		R42XLS	AC4	41804	0.8
Alfa Romeo	33		01/90	1992	4	1.7L	AR30737		41602		41970*	0.8
Alfa Romeo	75		1986	1992	6	2.5L	AR01911		R42XLS	AC4	41804	0.8
Alfa Romeo	75		1988	1991	6	3.0L	AR06124		R42XLS	AC4	41804	0.8
Alfa Romeo	90		1985	1988	6	2.5L			R42XLS	AC4	41804	0.8
Alfa Romeo	147	GTA	2003	2006	6	3.2L	932A000				41970*	0.7
Alfa Romeo	156		1997	2006	6	2.5L	AR32401				41970*	0.7
Alfa Romeo	156	JTS	2003	2006	4	2.0L	937A1000				41970*	0.7
Alfa Romeo	156		2005	2005	6	3.2L	932A0				41970*	0.7
Alfa Romeo	159		2006	2010	4	2.2L			41629		41969*	0.8
Alfa Romeo	159		2006	2011	6	3.2L			41629		41969*	0.8
Alfa Romeo	164		1991	1992	6	3.0L	AR06412	24V	41602		41970*	0.8
Alfa Romeo	166		1999	07/04	6	3.0L	AR34301				41970*	0.7
Alfa Romeo	166		1999	2004	6	3.2L	932A0				41970*	0.7
Alfa Romeo	Alfasud		1974	1977	4	1.2L			R42XLS		41804	0.7
Alfa Romeo	Alfasud		1979	1985	4	1.3L			R42XLS		41804	0.7
Alfa Romeo	Alfasud	Sprint	1979	1984	4	1.5L			R42XLS		41804	0.7
Alfa Romeo	Alfasud	Sprint Ti	1984	1985	4	1.5L			R42XLS		41804	0.7
Alfa Romeo	Alfetta		1974	1978	4	1.8L			R42XLS		41804	0.7
Alfa Romeo	Alfetta		1975	1978	4	1.6L			R42XLS		41804	0.7
Alfa Romeo	Alfetta	GT	1975	1976	4	1.8L			R42XLS		41804	0.7
Alfa Romeo	Alfetta	Sportiva	1978	1984	4	2.0L			R42XLS		41804	0.7
Alfa Romeo	Berlina	2600	1966	1967	6	2.6L			R42XLS		41804	0.7
Alfa Romeo	Berlina	1750	1968	1972	4	1.75L			R42XLS		41804	0.7
Alfa Romeo	Berlina	2000	1972	1976	4	2.0L			R42XLS		41804	0.7
Alfa Romeo	Brera		06/06	01/11	4	2.2L			41629		41969*	0.8
Alfa Romeo	Giulia		1964	1972	4	1.6L			R42XLS		41804	0.7
Alfa Romeo	Giulia	Ti	1964	1965	4	1.6L			R42XLS		41804	0.7
Alfa Romeo	Giulia	Ti	1968	1971	4	1.3L			R42XLS		41804	0.7
Alfa Romeo	Giulia		1971	1972	4	1.3L			R42XLS		41804	0.7
Alfa Romeo	Giulietta		1980	1984	4	1.8L			R42XLS		41804	0.7
Alfa Romeo	GTV		06/98	2004	6	3.0L					41970*	0.7
Alfa Romeo	GTV6		1983	1988	6	2.5L			R42XLS		41804	0.7

MAKE	MODEL	SERIES / BADGE	FROM	TO	CYLS	CAPACITY	ENGINE	ADDITIONAL INFORMATION	REGULAR	PLATINUM (RAPIDFIRE®)	DOUBLE PLATINUM	GAP (MM)#
Alfa Romeo	Montreal		1974	1976	8	2.6L			R42XLS		41804	0.7
ASIA MOTORS												
Asia Motors	Rocsta		07/93	2000	4	1.8L			R43XLS	AC4	41802	0.8
AUDI												
Audi	80		1983	on	4	1.6L			R42XLS	AC4	41804	0.8
Audi	80		1984	1989	4	1.8L	JN		R42XLS	AC4	41804	0.8
Audi	80		1987	1989	4	1.9L	SD		R42XLS	AC4	41804	0.8
Audi	80	2.0E	1988	1991	4	2.0L	3A		R42XLS	AC4	41804	0.8
Audi	80	2.0E	1989	1992	4	2.0L	AAD		R42XLS	AC4	41804	0.8
Audi	80	2.0E	1992	1995	4	2.0L	ABK		R42XLS	AC4	41804	0.8
Audi	80	2.3E	08/92	1994	5	2.3L	NG	SOHC	R43XLS	AC4	41802	0.8
Audi	80	2.8E	08/92	1994	6	2.8L	AAH	SOHC	41602	AC5	41801	1.0
Audi	80	2.6E	10/93	1999	6	2.6L	ABC	SOHC	41602	AC5	41801	1.0
Audi	80	Quattro 2.6E	10/93	1995	6	2.6L	ABC	SOHC	41602	AC5	41801	1.0
Audi	90		05/89	1992	5	2.3L	NG	SOHC	R43XLS	AC4	41802	0.8
Audi	90	Quattro 20V	09/89	1991	5	2.3L	7A	DOHC	FR11S			0.8
Audi	100	CD	12/83	1985	5	2.1L	KF	SOHC	R42XLS	AC4	41804	0.8
Audi	100	CD	12/83	1987	5	2.3L	HX	SOHC	R42XLS	AC4	41804	0.8
Audi	100	CD	01/88	1991	5	2.3L	NF	SOHC	R43XLS	AC4	41802	0.8
Audi	100	2.8E	01/92	1994	6	2.8L	AAH	SOHC	41602	AC5	41801	1.0
Audi	100	2.6E	10/93	1994	6	2.6L	ABC	SOHC	41602	AC5	41801	1.0
Audi	200	5T	1982	1984	5	2.1L	KJ	Turbo SOHC	R42XLS	AC4	41804	0.8
Audi	200	5T	1984	1990	5	2.1L	KG	Turbo SOHC	R42XLS	AC4	41804	0.8
Audi	200		10/86	1991	5	2.3L	MC	Turbo SOHC	R42XLS	AC4	41804	0.8
Audi	5+5		1981	1984	5	2.1L	WE		R42XLS	AC4	41804	0.8
Audi	5E		1978	1982	5	2.1L	WB		R42XLS	AC4	41804	0.8
Audi	A3		05/97	1999	4	1.6L	AEH	SOHC	41602	AC5	41801	1.0
Audi	A3		05/97	2004	4	1.8L	AGN	DOHC	41602	AC5	41801	1.0
Audi	A3		08/98	04/01	4	1.8L	AGU	Turbo DOHC	41602	AC5	41801	0.8
Audi	A3		11/00	2004	4	1.8L		DOHC	41602	AC5	41801	1.0
Audi	A3		06/04	on	4	1.6L	BGU		41602	AC5	41801	1.0
Audi	A3	FSI	06/04	2005	4	2.0L	BMB	DOHC			41806	1.1
Audi	A3	FSI	02/05	2007	4	2.0L	AXX	Turbo DOHC	41602	AC5	41801	0.8
Audi	A4		08/95	2001	4	1.8L	ADR	DOHC	41602	AC5	41801	0.8
Audi	A4		08/95	1998	6	2.6L	ABC	SOHC	41602	AC5	41801	1.0
Audi	A4		12/95	2000	4	1.8L	AEB	Turbo DOHC	41602	AC5	41801	0.8
Audi	A4	Quattro	12/95	1999	4	1.8L	AEB	Turbo DOHC	41602	AC5	41801	0.8
Audi	A4	Quattro	1996	1998	6	2.6L	ABC	SOHC	41602	AC5	41801	1.0
Audi	A4		02/97	2001	6	2.8L	ACK	DOHC	41602	AC5	41801	1.0
Audi	A4		1998	2003	6	2.4L	AGA		41602	AC5	41801	1.0
Audi	A4	Quattro	1998	2003	6	2.4L	AGA		41602	AC5	41801	1.0
Audi	A4		1999	2001	6	2.4L	APS		41602	AC5	41801	1.0
Audi	A4	Quattro	01/99	2001	4	1.8L	AJL	Turbo DOHC 132kW	41602	AC5	41801	0.7
Audi	A4		2001	2004	6	3.0L	ASN		41629		41800	0.8
Audi	A4		2001	2005	6	3.0L	BBJ		41629		41800	0.8
Audi	A4		07/01	2008	4	2.0L	ALT	DOHC	41629		41800	1.0
Audi	A4	Quattro	08/01	2005	4	1.8L	AVJ	Turbo DOHC 147kW	41602	AC5	41801	0.7

MAKE	MODEL	SERIES / BADGE	FROM	TO	CYLS	CAPACITY	ENGINE	ADDITIONAL INFORMATION	REGULAR	PLATINUM (RAPIDFIRE®)	DOUBLE PLATINUM	GAP (MM)#
Audi	A4	B6	2002	10/04	4	1.8L	BFB				41801	0.8
Audi	A4		04/02	2005	6	2.4L	BDV	DOHC	41602	AC5	41801	0.8
Audi	A4	B6 - 1.8T	04/02	03/05	4	1.8L	BFB				41801	0.8
Audi	A4	B6 - 1.8T Quattro	04/02	03/05	4	1.8L	BFB				41801	0.8
Audi	A4	B7 - 1.8T	11/04	08/09	4	1.8L	BFB	Convertible			41801	1.0
Audi	A4	B7 - 1.8T	03/05	03/08	4	1.8L	BFB	Sedan			41801	1.0
Audi	A4	B7 - 1.8T Avant	03/05	08/08	4	1.8L	BFB				41801	1.0
Audi	A4	B7 - 1.8T Quattro	03/05	03/08	4	1.8L	BFB				41801	1.0
Audi	A4	B7 - 2.0 TFSI	03/05	03/08	4	2.0L	BGB				41801	0.8
Audi	A4	B7 - 2.0 TFSI	03/05	03/08	4	2.0L	BWE				41801	1.0
Audi	A4	Quattro	06/05	2008	6	3.2L	AUK	DOHC	41602	AC5	41801	0.9
Audi	A4	B7 - 2.0 TFSI S-Line	11/07	08/09	4	2.0L	BWE				41801	1.0
Audi	A4	B8 - 1.8 TFSI	04/08	06/12	4	1.8L	CABB				41801	0.8
Audi	A4	B8 - 1.8 TFSI	04/08	06/12	4	1.8L	CDHB				41801	0.8
Audi	A4	B8 - 1.8 TFSI Avant	09/08	06/12	4	1.8L	CABB				41801	0.8
Audi	A4	B8 - 1.8 TFSI Avant	09/08	06/12	4	1.8L	CDHB				41801	0.8
Audi	A4	B8 - 2.0 TFSI	10/08	06/12	4	2.0L	CDNB				41801	0.8
Audi	A4	B8 - 2.0 TFSI Quattro	10/08	2014	4	2.0L	CDNC				41801	0.8
Audi	A4	B8 - 2.0 TFSI Avant	01/09	06/12	4	2.0L	CDNB				41801	0.8
Audi	A5	8T - 2.0 TFSI	05/09	02/12	4	2.0L	CDNB	Coupe			41801	0.8
Audi	A5	8T - 2.0 TFSI Quattro	05/09	2014	4	2.0L	CDNC	Coupe			41801	0.8
Audi	A5	8T - 2.0 TFSI Quattro	08/09	2014	4	2.0L	CDNC	Convertible			41801	0.8
Audi	A5	8T - Sportback 2.0TFSI	01/10	2014	4	2.0L	CDNC				41801	0.8
Audi	A5	8T - 2.0 TFSI	07/10	02/12	4	2.0L	CDNB	Convertible			41801	0.8
Audi	A5	8T - Sportback 2.0 TFSI	07/10	02/12	4	2.0L	CDNB				41801	0.8
Audi	A6	Quattro	06/94	10/97	6	2.8L	AAH		41602	AC5	41801	1.0
Audi	A6		11/94	1997	6	2.6L	ABC		41602	AC5	41801	1.0
Audi	A6	Quattro	11/94	1997	6	2.6L	ABC		41602	AC5	41801	1.0
Audi	A6		01/97	2000	6	2.8L	ACK		41602	AC5	41801	1.0
Audi	A6	Quattro	11/97	2001	6	2.4L	AGA	DOHC	41602	AC5	41801	1.0
Audi	A6	Quattro	11/97	2001	6	2.8L	ACK		41602	AC5	41801	1.0
Audi	A6	Quattro	2000	2002	6	2.8L	APR	30 Valve	41602	AC5	41801	0.8
Audi	A6		04/00	2001	6	2.4L	APS	DOHC	41602	AC5	41801	0.8
Audi	A6		2001	2004	6	3.0L	ASN	DOHC	41629		41800	0.8
Audi	A6	Quattro	2001	2004	6	3.0L	ASN	DOHC	41629		41800	0.8
Audi	A6		02/02	09/04	6	2.4L	BDV	DOHC	41602	AC5	41801	0.8
Audi	A6		02/02	05/05	6	3.0L	BBJ	DOHC	41629		41800	0.8
Audi	A6	Quattro	02/02	09/04	6	2.7L	ARE	BiTurbo	41602	AC5	41801	0.8
Audi	A6	Quattro	02/02	05/05	6	3.0L	BBJ	DOHC	41629		41800	0.8

MAKE	MODEL	SERIES / BADGE	FROM	TO	CYLS	CAPACITY	ENGINE	ADDITIONAL INFORMATION	REGULAR	PLATINUM (RAPIDFIRE®)	DOUBLE PLATINUM	GAP (MM)#
Audi	A6		10/04	06/05	8	4.2L	BAT		41629		41800	0.5
Audi	A6	C6 - 2.0 TFSI	09/06	02/11	4	2.0L	BPJ				41801	0.8
Audi	A6	C6 - 2.0 TFSI Avant	09/06	01/09	4	2.0L	BPJ				41801	0.8
Audi	A8		05/95	2000	8	4.2L	ABZ	With Tapered Seats	R42LTS		41810	0.8
Audi	A8	2.8E	05/95	1996	6	2.8L	AAH	SOHC	41602	AC5	41801	1.0
Audi	A8	Quattro	08/03	10/06	8	3.7L	BFL	DOHC	41602	AC5	41801	0.8
Audi	A8	Quattro	08/03	07/05	8	4.2L	BFM	DOHC	41629		41800	0.8
Audi	Allroad	C5 Quattro	02/01	2005	6	2.7L	ARE	Turbo DOHC	41602	AC5	41801	0.8
Audi	Fox		1976	1979	4	1.6L	FS		R42XLS	AC4	41804	0.8
Audi	Q5	8R - 2.0 TFSI Quattro	03/09	09/12	4	2.0L	CDNC				41801	0.8
Audi	RS4		02/01	04/02	6	2.7L	ASJ	Twin Turbo	FR1LS			0.8
Audi	RS6		11/03	01/05	8	4.2L	BCY	Twin Turbo	FR1LS			0.8
Audi	S2		10/93	1996	5	2.2L	ABY	Turbo DOHC	FR1LS			0.6
Audi	S3		11/99	2002	4	1.8L	APY	Turbo DOHC	41602	AC5	41801	0.8
Audi	S3		03/02	2004	4	1.8L	BAM	Turbo DOHC	41602	AC5	41801	0.8
Audi	S4		07/93	1995	4	2.2L	AAN	Turbo DOHC	FR1LS			0.6
Audi	S4		12/99	2003	6	2.7L	AGB	BiTurbo	41602	AC5	41801	0.8
Audi	S4		06/04	2008	8	4.2L	BBK		41629		41800	0.8
Audi	S6	Quattro	02/01	2002	8	4.2L	AQJ		41629		41800	0.8
Audi	S6	Quattro	2002	2004	8	4.2L	ANK		41629		41800	0.8
Audi	S8		07/98	1999	8	4.2L	AHC		R42LTS		41810	0.8
Audi	TT	Quattro	10/99	2002	4	1.8L	APX	Turbo 165kW	41602	AC5	41801	0.8
Audi	TT	Quattro	10/99	10/06	4	1.8L	BAM	Turbo 165kW	41602	AC5	41801	0.8
Audi	TT		2001	01/06	4	1.8L	AUQ		41602	AC5	41801	0.8
Audi	TT	Quattro	2001	2004	4	1.8L	ARY	Turbo 132kW	41602	AC5	41801	0.8
Audi	TT	8J - 2.0 TFSI	11/06	10/10	4	2.0L	BVA	Coupe			41801	0.8
Audi	TT	8J - 2.0 TFSI	06/07	10/10	4	2.0L	BVA	Roadster			41801	0.8
BMW												
BMW	1.6	E10	1967	1973	4	1.6L			R43XLS	AC4	41802	0.8
BMW	1.8	E10	1967	1969	4	1.8L			R43XLS	AC4	41802	0.8
BMW	3.0	E3	1972	1976	6	3.0L			R43XLS	AC4	41802	0.8
BMW	3.3	E3	1974	1975	6	3.3L			R43XLS	AC4	41802	0.8
BMW	320	E21	1976	1978	4	2.0L			43XLS	AC4		0.6
BMW	320	E21	1976	1978	4	2.0L	M20		R43XLS	AC4	41802	0.8
BMW	520	E12	08/73	1978	4	2.0L	M10		R42XLS	AC4	41804	0.6
BMW	525	E12	03/74	1975	6	2.5L	M30		R42XLS	AC4	41804	0.8
BMW	528		07/75	1982	6	2.8L	M30		R42XLS	AC4	41804	0.8
BMW	2002	E10	1968	1976	4	2.0L			R43XLS	AC4	41802	0.8
BMW	116i		02/05	02/08	4	1.6L	N45		41629		41800	0.5
BMW	118i	E87	2004	09/11	4	2.0L	N46B20				41806	1.1
BMW	120i	E87	10/04	02/07	4	2.0L	N46B		41629		41800	1.0
BMW	125i	E82	05/08	2014	6	3.0L	N52B30				41835*	1.1
BMW	125i	E88	05/08	2014	6	3.0L	N52B30				41835*	1.1
BMW	130i	E87	11/05	10/10	6	3.0L	N52B30				41835*	1.1
BMW	2000Ti	E10	1967	1969	4	2.0L			R43XLS	AC4	41802	0.8

MAKE	MODEL	SERIES / BADGE	FROM	TO	CYLS	CAPACITY	ENGINE	ADDITIONAL INFORMATION	REGULAR	PLATINUM (RAPIDFIRE®)	DOUBLE PLATINUM	GAP (MM)#
BMW	2002Ti	E10	1973	1975	4	2.0L			R43XLS	AC4	41802	0.8
BMW	316i	Compact	03/95	1999	4	1.6L	M43		41602	AC5	41801	1.0
BMW	316i	Compact	04/99	2001	4	1.9L	M46		41629		41800	1.0
BMW	316Ti	Compact	12/01	2003	4	1.8L	N42B18		41602	AC5	41801	1.0
BMW	318i	E30	11/88	1991	4	1.8L	M40				41806	0.8
BMW	318i	E36	04/91	11/93	4	1.8L	M40B18		41602	AC5	41801	0.8
BMW	318i	E36	04/91	1998	4	1.8L	M43		41602	AC5	41801	1.0
BMW	318i	E46	09/98	2001	4	1.9L	M43TU		41629		41800	0.5
BMW	318i	E46	2001	04/05	4	2.0L	N46B20				41806	1.1
BMW	318i	E46	12/01	2005	4	2.0L	N42B20		41602	AC5	41801	1.0
BMW	318i	E21	03/80	04/83	4	1.8L	M10B18		43XLS	AC4		0.6
BMW	318i	E30	10/83	12/87	4	1.8L	M10B18		43XLS	AC4		0.6
BMW	318iS	E30	07/90	1991	4	1.8L	M42		41602	AC5	41801	0.8
BMW	318iS	E36	1991	1995	4	1.8L	M42		41602	AC5	41801	0.9
BMW	318iS	E36	1996	12/99	4	1.9L	M44		41602	AC5	41801	1.0
BMW	318Ti	E36	05/96	12/99	4	1.9L	M44		41602	AC5	41801	1.0
BMW	318Ti	Compact	12/01	2005	4	2.0L	N42B20		41629		41800	1.0
BMW	318Ti	E46 Compact	2004	07/05	4	2.0L	N46B20				41800	1.1
BMW	320Ci	E46	2000	2006	6	2.2L	M54		41629		41800	1.0
BMW	320i	E21	03/76	1979	4	2.0L	M10		R42XLS	AC4	41804	0.6
BMW	320i	E30	02/88	1990	6	2.0L	M20		R43XLS	AC4	41802	0.8
BMW	320i	E36	04/91	1995	6	2.0L	M50	24V	41602	AC5	41801	0.8
BMW	320i	E46	01/00	05/07	6	2.2L	M54		41629		41800	1.0
BMW	320i	E90	05/05	01/12	4	2.0L	N46		41629		41800	1.1
BMW	320i	E91	06/07	2014	4	2.0L	N46B20				41806	1.1
BMW	323A	E21	06/79	1983	4	2.3L	M20		R43XLS	AC4	41802	0.8
BMW	323Ci		1999	2000	6	2.5L	M52		41602	AC5	41801	1.0
BMW	323i	E21	06/79	1983	4	2.3L	M20		R43XLS	AC4	41802	0.8
BMW	323i	E30	11/93	12/85	6	2.3L	M20B23		R43XLS	AC4	41802	0.8
BMW	323i	E36	01/96	1998	6	2.5L	M52		41602	AC5	41801	1.0
BMW	323i	E46	1998	2000	6	2.5L	M52		41602	AC5	41801	1.0
BMW	323i	E90	2005	01/12	6	2.5L	N52B25				41835*	1.1
BMW	323i	E91	06/06	09/12	6	2.5L	N52B25				41835*	1.1
BMW	323i	E92	01/07	04/10	6	2.5L	N52B25				41835*	1.1
BMW	325Ci		2000	2007	6	2.5L	M54		41602	AC5	41801	1.0
BMW	325Ci	E46	2000	02/07	6	2.5L	M54B25		41629		41800	1.6
BMW	325e	E30	01/86	1987	6	2.7L	M20		R43XLS	AC4	41802	0.8
BMW	325i	E30	01/88	1991	6	2.5L	M20		R43XLS	AC4	41802	0.8
BMW	325i		04/91	1995	6	2.5L	M50		41602	AC5	41801	0.8
BMW	325i		2000	2004	6	2.5L	M54		41602	AC5	41801	1.0
BMW	325i	E46	2000	01/04	6	2.5L	M54B25		41629		41800	1.6
BMW	325i	E91	2005	2007	6	2.5L	N52B25				41835*	1.1
BMW	325i	E90	07/05	01/12	6	2.5L	N52B25				41835*	1.1
BMW	325i	E92	10/06	on	6	2.5L	N52B25				41835*	1.1
BMW	325i	E93	03/07	on	6	2.5L	N52B25				41835*	1.1
BMW	325iS	E30	09/88	1990	6	2.5L	M20		41602	AC5	41801	0.8
BMW	325Ti	Compact	2001	07/05	6	2.5L	M54B25		41629		41800	1.6

MAKE	MODEL	SERIES / BADGE	FROM	TO	CYLS	CAPACITY	ENGINE	ADDITIONAL INFORMATION	REGULAR	PLATINUM (RAPIDFIRE®)	DOUBLE PLATINUM	GAP (MM)#
BMW	328Ci	E36	06/95	1999	6	2.8L	M52	24V	41602	AC5	41801	1.0
BMW	328Ci	E46	06/99	09/00	6	2.8L	M52		41602	AC5	41801	1.0
BMW	328i	E36	06/95	2000	6	2.8L	M52	24V	41602	AC5	41801	1.0
BMW	328i	E46	09/98	2000	6	2.8L	M52		41602	AC5	41801	1.0
BMW	330Ci	E46	2000	2007	6	3.0L	M54B30		41629		41800	1.6
BMW	330i	E46	2000	2005	6	3.0L	M54B30		41629		41800	1.6
BMW	330i	E90	05/05	11/06	6	3.0L	N52B30				41835*	1.1
BMW	520i	E12	08/73	1978	4	2.0L	M10		R42XLS	AC4	41804	0.6
BMW	520i		1983	1985	6	2.0L			43XLS	AC4		0.8
BMW	520i	E34	11/90	1996	6	2.0L	M50	24V	41602	AC5	41801	0.8
BMW	523i	E39	04/96	2000	6	2.5L	M52		41602	AC5	41801	0.8
BMW	523i		03/05	2008	6	2.5L	N52				41835*	0.8
BMW	525e		01/86	1988	6	2.7L	M20		R43XLS	AC4	41802	0.8
BMW	525i	E34	09/88	1990	6	2.5L	M20		R43XLS	AC4	41802	0.8
BMW	525i	E34	11/90	1996	6	2.5L	M50		41602	AC5	41801	0.8
BMW	525i	E39	12/00	10/03	6	2.5L	M54		41629		41800	1.0
BMW	525i		10/03	2005	6	2.5L	M54		41629		41800	1.0
BMW	525i	E60	2004	2008	6	2.5L	N52B25				41835*	1.1
BMW	528i		1981	1985	6	2.8L	M30		43XLS	AC4		0.8
BMW	528i	E39	04/96	11/00	6	2.8L	M52		41602	AC5	41801	0.8
BMW	528i	E39 Touring	09/98	01/01	6	2.8L	M52		41602	AC5	41801	0.8
BMW	530i	E34	06/93	1996	8	3.0L	M60		41629		41800	0.9
BMW	530i	E39	12/00	2003	6	3.0L	M54		41629		41800	1.0
BMW	530i	E39 Touring	12/00	2003	6	3.0L	M54		41629		41800	1.0
BMW	535i	E28	01/86	1988	6	3.5L	M30		R43XLS	AC4	41802	0.8
BMW	535i	E39	10/96	1998	8	3.5L	M62B35		41629		41800	0.9
BMW	535i	E34	09/98	05/93	6	3.4L	M30		R43XLS	AC4	41802	0.8
BMW	535i	E39	09/98	2003	8	3.5L	M62TUB35		41629		41800	1.0
BMW	535iS	E34	1988	1991	6	3.4L	M30		R43XLS	AC4	41802	0.8
BMW	540i	E34	1993	1996	8	4.0L	M60		41629		41800	1.0
BMW	540i	E39	10/96	09/98	8	4.4L	M62B44		41629		41800	1.0
BMW	540i	E39	09/98	2003	8	4.4L	M62TUB44		41629		41800	1.0
BMW	545i		10/03	2005	8	4.4L	N62B		41629		41800	1.0
BMW	550i	E60	11/05	06/10	8	4.8L	N62B48				41806	1.1
BMW	633 CSi		1977	1980	6	3.2L	M30B32		43XLS	AC4		0.8
BMW	635 CSi		1979	1982	6	3.4L	M30B34		43XLS	AC4		0.8
BMW	635CSi	E24	1979	1989	6	3.4L	M30B34		R43XLS	AC4	41802	0.8
BMW	645Ci	E63	05/04	10/05	8	4.4L	N62B44				41806	1.6
BMW	645Ci	E64	05/04	10/05	8	4.4L	N62B44				41806	1.6
BMW	650i	E63	2005	03/12	8	4.8L	N62B48				41806	1.1
BMW	650i	E64	2005	04/11	8	4.8L	N62B48				41806	1.1
BMW	728i	E23	1980	1987	6	2.8L	M30		R43XLS	AC4	41802	0.8
BMW	730i	E32	11/90	1992	6	3.0L	M30		R43XLS	AC4	41802	0.8
BMW	730iL	E32	11/90	1994	8	3.0L	M60		41629		41800	0.9
BMW	730iL		10/94	1996	8	3.0L	M60		41629		41800	0.9
BMW	733i	E23	02/78	1983	6	3.3L	M30		R43XLS	AC4	41802	0.8

MAKE	MODEL	SERIES / BADGE	FROM	TO	CYLS	CAPACITY	ENGINE	ADDITIONAL INFORMATION	REGULAR	PLATINUM (RAPIDFIRE®)	DOUBLE PLATINUM	GAP (MM)#
BMW	735i	E23	05/83	1984	6	3.2L	M30		R43XLS	AC4	41802	0.8
BMW	735i	E32	1987	1990	6	3.4L	M30	Unleaded	R43XLS	AC4	41802	0.8
BMW	735i		08/96	01/02	8	3.5L	M62		41629		41800	1.0
BMW	735i	E65	01/02	05/05	8	3.6L	N62B36		41629		41800	1.0
BMW	735iL	E32	1988	1992	6	3.4L	M30		R43XLS	AC4	41802	0.8
BMW	735iL		08/96	12/00	8	3.5L	M62		41629		41800	1.0
BMW	735Li	E66	08/02	05/05	8	3.6L	N62B36		41629		41800	1.0
BMW	740i	E38	1994	1996	8	4.0L	M60B40		41629		41800	0.9
BMW	740iL		11/92	06/96	8	4.0L	M60		41629		41800	1.0
BMW	740iL	E32	11/92	1994	8	4.0L	M60		41629		41800	0.9
BMW	740iL	E38	11/94	06/96	8	4.0L	M60B40		41629		41800	0.9
BMW	740iL	E38	07/96	12/00	8	4.4L	M62		41629		41800	1.0
BMW	745i	E65	01/02	05/05	8	4.4L	N62B44		41629		41800	1.0
BMW	750i	E65	06/05	02/09	8	4.8L	N62B48				41806	1.1
BMW	750iL	E32	10/88	1994	12	5.0L	M70				41806	0.6
BMW	750iL		11/94	01/02	12	5.4L	M73				41806	0.8
BMW	750Li	E66	06/05	02/09	8	4.8L	N62B48				41806	1.1
BMW	760iL	E66	05/03	02/09	12	6.0L	N73		41629		41800	1.0
BMW	840Ci		1993	2000	8	4.0L	M60		41629		41800	1.0
BMW	840Ci		1996	2000	8	4.4L	M62		41629		41800	1.0
BMW	850Ci		1991	1994	12	5.0L	M70				41806	0.6
BMW	850i		1990	1996	12	5.0L	M70				41806	0.6
BMW	M		09/98	2001	6	3.2L	S54B30		41629		41800	1.0
BMW	M3		01/94	1996	6	3.0L	S50B30		41629		41800	0.9
BMW	M3		02/96	1998	6	3.2L	S50B32				41806	1.0
BMW	M3		09/98	2001	6	3.2L	S50B32		41629		41800	0.9
BMW	M5	E39	09/98	09/03	8	5.0L	S62		41629		41800	1.0
BMW	M5	E63	01/06	10/10	10	5.0L	S85B50		41629		41800	0.9
BMW	M535i		1986	1988	6	3.4L			43XLS	AC4		0.8
BMW	X3		06/04	02/11	6	2.5L	M54		41629		41800	1.0
BMW	X3		06/04	11/06	6	3.0L	M54		41629		41800	1.0
BMW	X3	E83 - 3.0si xDRIVE 30i	12/06	02/11	6	3.0L	N52B30				41835*	1.1
BMW	X5		09/99	02/07	6	3.0L	M54		41629		41800	1.0
BMW	X5		09/99	12/03	8	4.4L	M62		41629		41800	1.0
BMW	X5		09/99	10/03	8	4.6L	M62		41629		41800	1.0
BMW	X5	E53	01/04	02/07	8	4.4L	N62B44				41800	1.6
BMW	X5		03/04	05/10	8	4.8L	N62		41629		41800	0.5
BMW	X5	E70 - 3.0si xDRIVE 30i	03/07	05/10	6	3.0L	N52B30				41835*	1.1
BMW	X6	E70	07/08	on	6	3.0L					41806	1.1
BMW	Z3		01/97	1999	4	1.9L	M44				41806	1.0
BMW	Z3		02/97	2000	6	2.8L	M52		41602	AC5	41801	1.0
BMW	Z3		06/99	2000	6	2.0L	M52		41602	AC5	41801	1.0
BMW	Z3		10/00	2002	6	2.2L	M54		41629		41800	1.0
BMW	Z3		10/00	2002	6	3.0L	M54		41629		41800	1.0
BMW	Z4	B25	03/04	03/06	6	2.5L	M54		41629		41800	1.0
BMW	Z4	B30	03/04	03/06	6	3.0L	M54		41629		41800	1.0
BMW	Z4	E85 - 2.5si	04/06	04/09	6	2.5L	N52B25				41835*	1.1

MAKE	MODEL	SERIES / BADGE	FROM	TO	CYLS	CAPACITY	ENGINE	ADDITIONAL INFORMATION	REGULAR	PLATINUM (RAPIDFIRE®)	DOUBLE PLATINUM	GAP (MM)#
BMW	Z4	E85 - 3.0si	10/06	04/09	6	3.0L	N52B30				41835*	1.1
BMW	Z4	E86 - 3.0si	10/06	04/09	6	3.0L	N52B30				41835*	1.1
BUICK												
Buick	Electra		1967	1967	8	7.0L		4 BBL Vin NE ND	R44TS			0.8
Buick	Electra		1970	1970	8	7.5L		4 BBL Vin SF	R44TS			0.8
Buick	Electra		1971	1971	8	7.5L		4 BBL Vin TR	R44TS			0.8
Buick	Regal		1975	1977	8	5.7L		2 BBL Vin H			41826	1.5
Buick	Regal		1975	1977	8	5.7L		4 BBL Vin J			41826	1.5
Buick	Regal		1986	1987	8	5.0L		4 BBL Vin Y		AC5		1.1
Buick	Riviera		1966	1966	8	7.0L		2x4 BBL			41833	0.8
Buick	Riviera		1967	1967	8	7.0L		4 BBL Vin NE ND	R44TS			0.8
Buick	Riviera		1968	1968	8	7.0L		4 BBL Vin PD	R44TS			0.8
Buick	Riviera		1969	1969	8	7.0L		4 BBL Vin RD RE	R44TS			0.8
Buick	Riviera		1970	1970	8	7.5L		4 BBL Vin SF	R44TS			0.8
Buick	Riviera		1971	1971	8	7.5L		4 BBL Vin TR	R44TS			0.8
Buick	Riviera		1975	1976	8	7.5L		4 BBL Vin T			41826	1.5
Buick	Riviera		1977	1977	8	5.7L		4 BBL Vin J			41826	1.5
Buick	Riviera		1978	1978	8	5.7L		4 BBL Vin X			41826	1.5
Buick	Riviera		1985	1985	8	5.0L		4 BBL Vin Y		AC5		1.1
Buick	Skylark		1966	1966	8	4.9L		2 BBL			41833	0.8
Buick	Skylark		1966	1966	8	5.6L		2 BBL			41833	0.8
Buick	Skylark		1966	1966	8	6.6L		CARB			41833	0.8
Buick	Skylark		1967	1967	8	4.9L		2 BBL Vin NM			41833	0.8
Buick	Skylark		1967	1967	8	5.6L		2 BBL Vin NA			41833	0.8
Buick	Skylark		1975	1976	8	5.7L		2 BBL Vin H			41826	1.5
Buick	Skylark		1975	1976	8	5.7L		4 BBL Vin J			41826	1.5
Buick	Special		1966	1966	8	4.9L		2 BBL			41833	0.8
Buick	Special		1967	1967	8	4.9L		2 BBL Vin NM			41833	0.8
Buick	Sportwagon		1966	1966	8	5.6L		2 BBL			41833	0.8
Buick	Sportwagon		1967	1967	8	5.6L		CARB			41833	0.8
Buick	Sportwagon		1968	1968	8	6.6L		4 BBL Vin PR	R44TS			0.8
Buick	Wildcat		1966	1966	8	6.6L		4 BBL			41833	0.8
Buick	Wildcat		1966	1966	8	7.0L		2x4 BBL			41833	0.8
Buick	Wildcat		1967	1967	8	7.0L		4 BBL Vin NE ND	R44TS			0.8
Buick	Wildcat		1970	1970	8	7.5L		4 BBL Vin SF	R44TS			0.9
CADILLAC												
Cadillac	Brougham		1990	1990	8	5.0L	307	4 BBL Vin 9 (Brougham)		AC5		1.1
Cadillac	Calais		1968	1968	8	7.7L	472	4 BBL Vin 8	R44XLS		41802	0.9
Cadillac	Calais		1969	1969	8	7.7L	472	4 BBL Vin 9	R44XLS		41802	0.9
Cadillac	CTS V		2004	2005	8	5.7L	350	F/I Vin S (V)		AC6		1.1
Cadillac	CTS V		2004	2007	8	6.0L	364	F/I Vin U (V)		AC6	41805	1.2
Cadillac	Deville		1966	1966	8	7.0L	429	4 BBL			41833	0.9
Cadillac	Deville		1967	1967	8	7.0L	429	4 BBL Vin 7			41833	0.9

MAKE	MODEL	SERIES / BADGE	FROM	TO	CYLS	CAPACITY	ENGINE	ADDITIONAL INFORMATION	REGULAR	PLATINUM (RAPIDFIRE®)	DOUBLE PLATINUM	GAP (MM)#
Cadillac	Deville		1968	1968	8	7.7L	472	4 BBL Vin 8	R44XLS	AC4	41802	0.9
Cadillac	Deville		1969	1969	8	7.7L	472	4 BBL Vin 9	R44XLS	AC4	41802	0.9
Cadillac	Deville		1970	1970	8	7.7L	472	4 BBL Vin 1	R44XLS	AC4		0.9
Cadillac	Deville		1971	1971	8	7.7L	472	4 BBL Vin 3	R44XLS	AC4		0.9
Cadillac	Deville		1972	1974	8	7.7L	472	4 BBL Vin R	R44XLS	AC4		0.9
Cadillac	Deville		1976	1976	8	8.2L	500	F/I Vin S		AC4		1.0
Cadillac	Deville		1977	1979	8	7.0L	425	4 BBL Vin S		AC4		1.0
Cadillac	Deville		1977	1979	8	7.0L	425	F/I Vin T		AC4		1.0
Cadillac	Deville		1980	1980	8	6.0L	368	4 BBL Vin 6		AC4		1.0
Cadillac	Deville		1981	1981	8	6.0L	368	F/I Vin 9		AC4		1.0
Cadillac	Deville		1982	1983	8	4.1L	250	F/I Vin 8	R42LTS6	AC8	41942	1.5
Cadillac	Deville		1984	1987	8	4.1L	250	F/I Vin 8		AC14		1.5
Cadillac	Deville		1988	1989	8	4.5L	273	F/I Vin 5		AC14		1.5
Cadillac	Deville		1990	1990	8	4.5L	273	F/I Vin 3	R44LTS6	AC14		1.5
Cadillac	Deville		1991	1995	8	4.9L	300	F/I Vin B		AC14		1.5
Cadillac	Deville		1996	1996	8	4.6L	281	F/I Vin Y	R44LTS6	AC14		1.2
Cadillac	Deville Concours		1994	1995	8	4.6L	281	F/I Vin Y	R44LTS6	AC14		1.2
Cadillac	Deville Concours		1996	1996	8	4.6L	281	F/I Vin 9	R44LTS6	AC14		1.2
Cadillac	Eldorado		1966	1966	8	7.0L	429	4 BBL			41833	0.9
Cadillac	Eldorado		1967	1967	8	7.0L	429	4 BBL Vin 7			41833	0.9
Cadillac	Eldorado		1968	1968	8	7.7L	472	4 BBL Vin 8	R44XLS	AC4	41802	0.9
Cadillac	Eldorado		1969	1969	8	7.7L	472	4 BBL Vin 9	R44XLS	AC4	41802	0.9
Cadillac	Eldorado		1970	1971	8	8.2L	500	4 BBL Vin 4	R44XLS	AC4		0.9
Cadillac	Eldorado		1972	1973	8	8.2L	500	4 BBL Vin S	R44XLS	AC4		0.9
Cadillac	Eldorado		1974	1976	8	8.2L	500	4 BBL Vin S		AC4		0.9
Cadillac	Eldorado		1976	1976	8	8.2L	500	F/I Vin S		AC4		1.0
Cadillac	Eldorado		1977	1978	8	7.0L	425	4 BBL Vin S		AC4		1.0
Cadillac	Eldorado		1977	1978	8	7.0L	425	F/I Vin T		AC4		1.0
Cadillac	Eldorado		1980	1981	8	6.0L	368	F/I Vin 9		AC4		1.0
Cadillac	Eldorado		1982	1983	8	4.1L	250	F/I Vin 8	R42LTS6	AC8	41942	1.5
Cadillac	Eldorado		1984	1987	8	4.1L	250	F/I Vin 8	R44LTS6	AC14		1.5
Cadillac	Eldorado		1988	1989	8	4.5L	273	F/I Vin 5	R44LTS6	AC14		1.5
Cadillac	Eldorado		1988	1989	8	4.5L	273	F/I Vin 5	R44LTS6	AC14		1.5
Cadillac	Eldorado		1990	1990	8	4.5L	273	F/I Vin 3	R44LTS6	AC14		1.5
Cadillac	Eldorado		1992	1992	8	4.9L	300	F/I Vin B	R44LTS6	AC14		1.5
Cadillac	Eldorado		1994	1996	8	4.6L	281	F/I Vin Y	R44LTS6	AC14		1.2
Cadillac	Eldorado		1994	1996	8	4.6L	281	F/I Vin 9 (Touring)	R44LTS6	AC14		1.2
Cadillac	Eldorado Sport Coupe		1993	1993	8	4.6L	281	F/I Vin Y (Sport)	R44LTS6	AC14		1.5
Cadillac	Eldorado Tour- ing Coupe		1993	1993	8	4.6L	281	F/I Vin 9 (Touring)	R44LTS6	AC14		1.5
Cadillac	Escalade		1999	1999	8	5.7L	350	F/I Vin R	R44LTS6	AC14	41942	1.5
Cadillac	Escalade		2000	2000	8	5.7L	350	F/I Vin R	R44LTS6			1.5
Cadillac	Escalade		2002	2005	8	5.3L	325	F/I Vin T		AC6		1.1
Cadillac	Escalade		2002	2003	8	6.0L	364	F/I Vin N		AC6		1.1
Cadillac	Escalade		2005	2006	8	6.0L	364	F/I Vin N			41805	1.0
Cadillac	Escalade		2007	2007	8	6.2L		F/I Vin 8		AC6		1.0

MAKE	MODEL	SERIES / BADGE	FROM	TO	CYLS	CAPACITY	ENGINE	ADDITIONAL INFORMATION	REGULAR	PLATINUM (RAPIDFIRE®)	DOUBLE PLATINUM	GAP (MM)#
Cadillac	Fleetwood		1966	1966	8	7.0L	429	4 BBL			41833	0.9
Cadillac	Fleetwood		1983	1984	8	6.0L	368	4 BBL Vin 6		AC4		1.0
Cadillac	Fleetwood		1984	1984	8	6.0L	368	F/I Vin 9		AC4		1.0
Cadillac	Fleetwood		1990	1990	8	4.5L	273	F/I Vin 3	R44LTS6	AC14		1.5
Cadillac	Fleetwood		1991	1992	8	4.9L	300	F/I Vin B		AC14		1.5
Cadillac	Fleetwood		1994	1996	8	5.7L	350	F/I Vin P	R44LTS6	AC14		1.2
Cadillac	Fleetwood Brougham		1967	1967	8	7.0L	429	4 BBL Vin 7			41833	0.9
Cadillac	Fleetwood Brougham		1968	1968	8	7.7L	472	4 BBL Vin 8	R44XLS	AC4	41802	0.9
Cadillac	Fleetwood Brougham		1969	1969	8	7.7L	472	4 BBL Vin 9	R44XLS	AC4	41802	0.9
Cadillac	Fleetwood Brougham		1970	1970	8	7.7L	472	4 BBL Vin 1	R44XLS	AC4		0.9
Cadillac	Fleetwood Brougham		1971	1971	8	7.7L	472	4 BBL Vin 3		AC4		1.0
Cadillac	Fleetwood Brougham		1972	1974	8	7.7L	472	4 BBL Vin R		AC4		1.0
Cadillac	Fleetwood Brougham		1975	1976	8	8.2L	500	4 BBL Vin S		AC4		1.0
Cadillac	Fleetwood Brougham		1976	1976	8	8.2L	500	F/I Vin S		AC4		1.0
Cadillac	Fleetwood Brougham		1977	1979	8	7.0L	425	4 BBL Vin S		AC4		1.0
Cadillac	Fleetwood Brougham		1977	1979	8	7.0L	425	F/I Vin T		AC4		1.0
Cadillac	Fleetwood Brougham		1980	1980	8	6.0L	368	4 BBL Vin 6		AC4		1.0
Cadillac	Fleetwood Brougham		1981	1983	8	6.0L	368	F/I Vin 9		AC4		1.0
Cadillac	Fleetwood Brougham		1982	1983	8	4.1L	250	F/I Vin 8 (Brougham)	R42LTS6	AC8	41942	1.5
Cadillac	Fleetwood Brougham		1984	1984	8	4.1L	250	F/I Vin 8 (Brougham)	R44LTS6	AC14		1.5
Cadillac	Fleetwood Brougham		1985	1987	8	4.1L	250	F/I Vin 8	R44LTS6	AC14		1.5
Cadillac	Fleetwood Brougham		1986	1990	8	5.0L	307	4 BBL Vin Y (Brougham)		AC5		1.1
Cadillac	Fleetwood Brougham		1987	1989	8	5.0L	307	4 BBL Vin 9 (Brougham)		AC5		1.1
Cadillac	Fleetwood Brougham		1988	1989	8	4.5L	273	F/I Vin 5	R44LTS6	AC14		1.5
Cadillac	Seville		1980	1981	8	6.0L	368	F/I Vin 9		AC4		1.0
Cadillac	Seville		1982	1983	8	4.1L	250	F/I Vin 8	R42LTS6	AC8	41942	1.5
Cadillac	Seville		1984	1987	8	4.1L	250	F/I Vin 8	R44LTS6	AC14		1.5
Cadillac	Seville		1988	1989	8	4.5L	273	F/I Vin 5	R44LTS6	AC14		1.5
Cadillac	Seville		1990	1990	8	4.5L	273	F/I Vin 3	R44LTS6	AC14		1.5
Cadillac	Seville		1991	1993	8	4.9L	300	F/I Vin B		AC14		1.5
Cadillac	Seville		1992	1992	8	4.9L	300	F/I Vin B	R44LTS6			1.5
Cadillac	Seville SLS		1994	1996	8	4.6L	281	F/I Vin Y (SLS)	R44LTS6	AC14		1.2
Cadillac	Seville STS		1993	1996	8	4.6L	281	F/I Vin 9 (STS)	R44LTS6	AC14		1.5
CHEVROLET												
Chevrolet	Bel Air		1966	1966	8	4.6L	283	2 BBL			41833	0.9
Chevrolet	Bel Air		1966	1966	8	5.4L	327	4 BBL			41833	0.9

MAKE	MODEL	SERIES / BADGE	FROM	TO	CYLS	CAPACITY	ENGINE	ADDITIONAL INFORMATION	REGULAR	PLATINUM (RAPIDFIRE®)	DOUBLE PLATINUM	GAP (MM)#
Chevrolet	Bel Air		1967	1967	8	4.6L	283	2 BBL Vin GS GU GF GO			41833	0.9
Chevrolet	Bel Air		1967	1967	8	5.4L	327	4 BBL Vin HA HC			41833	0.9
Chevrolet	Bel Air		1968	1968	8	5.0L	307	2 BBL Vin DK DO DP DS			41833	0.9
Chevrolet	Bel Air		1968	1968	8	5.4L	327	4 BBL Vin HK HL HM HN			41833	0.9
Chevrolet	Bel Air		1969	1969	8	5.4L	327	2 BBL Vin FJ FK FL			41833	0.9
Chevrolet	Bel Air		1969	1969	8	5.7L	350	2 BBL Vin HI HJ			41833	0.9
Chevrolet	Bel Air		1970	1970	8	5.7L	350	2 BBL Vin CND CNS			41833	0.9
Chevrolet	Bel Air		1971	1971	8	6.6L	400	2 BBL Vin CLR CLK	R44TS			0.9
Chevrolet	Bel Air		1971	1971	8	6.6L	402	4 BBL Vin CLB	R44TS			0.9
Chevrolet	Biscayne		1966	1966	8	4.6L	283	2 BBL			41833	0.9
Chevrolet	Biscayne		1966	1966	8	5.4L	327	4 BBL			41833	0.9
Chevrolet	Biscayne		1967	1967	8	4.6L	283	2 BBL Vin GS GU GF GO			41833	0.9
Chevrolet	Biscayne		1967	1967	8	5.4L	327	4 BBL Vin HA HC			41833	0.9
Chevrolet	Biscayne		1968	1968	8	5.0L	307	2 BBL Vin DK DO DP DS			41833	0.9
Chevrolet	Biscayne		1968	1968	8	5.4L	327	4 BBL Vin HM HJ HL			41833	0.9
Chevrolet	Biscayne		1969	1969	8	5.4L	327	2 BBL Vin FJ FK FL			41833	0.9
Chevrolet	Biscayne		1969	1969	8	5.7L	350	2 BBL Vin IN HM HJ HL			41833	0.9
Chevrolet	Biscayne		1970	1970	8	5.7L	350	2 BBL Vin CND CNS			41833	0.9
Chevrolet	Biscayne		1971	1971	8	6.6L	400	2 BBL Vin CLK CLR	R44TS			0.9
Chevrolet	Biscayne		1971	1971	8	6.6L	402	4 BBL Vin CLB	R44TS			0.9
Chevrolet	Blazer		1969	1969	8	5.0L	307	CARB Vin E			41833	0.9
Chevrolet	Blazer		1970	1970	8	5.0L	307	2 BBL Vin A			41833	0.9
Chevrolet	Blazer		1970	1970	8	5.0L	307	2 BBL Vin B			41833	0.9
Chevrolet	Camaro		1967	1967	8	5.4L	327	2 BBL Vin MA MB ME MF			41833	0.9
Chevrolet	Camaro		1967	1967	8	5.7L	350	4 BBL Vin MS MT MU MV			41833	0.9
Chevrolet	Camaro		1967	1967	8	6.5L	396	4 BBL Vin MW MX MY MZ	R43XLS	AC4		0.9
Chevrolet	Camaro		1967	1967	8	6.5L	396	4 BBL Vin MW MX MY MZ	R44XLS	AC4		0.9
Chevrolet	Camaro		1968	1968	8	5.4L	327	2 BBL Vin MA ME			41833	0.9
Chevrolet	Camaro		1968	1968	8	5.7L	350	4 BBL Vin MS MU			41833	0.9
Chevrolet	Camaro		1968	1968	8	6.5L	396	4 BBL Vin MW MX MY	R43XLS	AC4		0.9
Chevrolet	Camaro		1968	1968	8	6.5L	396	4 BBL Vin MW MX MY	R44XLS	AC4		0.9

MAKE	MODEL	SERIES / BADGE	FROM	TO	CYLS	CAPACITY	ENGINE	ADDITIONAL INFORMATION	REGULAR	PLATINUM (RAPIDFIRE®)	DOUBLE PLATINUM	GAP (MM)#
Chevrolet	Camaro		1969	1969	8	5.4L	327	2 BBL Vin FJ FK FL			41833	0.9
Chevrolet	Camaro		1969	1969	8	5.7L	350	2 BBL Vin HC HF HD			41833	0.9
Chevrolet	Camaro		1969	1969	8	6.5L	396	4 BBL Vin JF JI KA	R43XLS	AC4		0.9
Chevrolet	Camaro		1969	1969	8	6.5L	396	4 BBL Vin JF JI KA	R44XLS	AC4		0.9
Chevrolet	Camaro		1970	1970	8	5.7L	350	2 BBL Vin GA GC			41833	0.9
Chevrolet	Camaro		1971	1971	8	6.6L	402	4 BBL Vin LA LB LC LD	R44TS			0.9
Chevrolet	Camaro		1985	1985	8	5.0L	305	4 BBL Vin G	R44TS			1.1
Chevrolet	Camaro		1999	2002	8	5.7L	350	F/I Vin G		AC6		1.1
Chevrolet	Camaro Z28		1967	1967	8	5.0L	307	4 BBL Vin MO MP			41833	0.9
Chevrolet	Camaro Z28		1993	1997	8	5.7L	350	F/I Vin P (Z28)		AC14		1.5
Chevrolet	Camaro Z28		1998	2000	8	5.7L	350	F/I Vin G		AC6		1.1
Chevrolet	Chevelle		1966	1966	8	4.6L	283	2 BBL			41833	0.9
Chevrolet	Chevelle		1966	1966	8	6.5L	396	4 BBL Vin (SS)	R43XLS	AC4		0.9
Chevrolet	Chevelle		1966	1966	8	6.5L	396	4 BBL Vin (SS)	R44XLS	AC4		0.9
Chevrolet	Chevelle		1967	1967	8	4.6L	283	2 BBL Vin DA DE			41833	0.9
Chevrolet	Chevelle		1969	1969	8	5.0L	307	2 BBL Vin DA DE DC DD			41833	0.9
Chevrolet	Chevelle		1969	1969	8	5.7L	350	2 BBL Vin HC HD HF			41833	0.9
Chevrolet	Chevelle		1969	1969	8	6.5L	396	CARB	R43XLS			1.0
Chevrolet	Chevelle		1969	1969	8	6.5L	396	CARB	R44XLS			0.9
Chevrolet	Chevelle		1970	1970	8	5.0L	307	2 BBL Vin CCA			41833	0.9
Chevrolet	Chevelle		1970	1970	8	5.7L	350	2 BBL Vin GA GC			41833	0.9
Chevrolet	Chevelle		1971	1971	8	6.6L	400	CARB	R44TS			0.9
Chevrolet	Chevelle SS396		1967	1967	8	6.5L	396	4 BBL Vin EG EX	R44XLS			0.9
Chevrolet	Chevelle SS396		1968	1968	8	6.5L	396	4 BBL Vin EG	R43XLS			0.9
Chevrolet	Chevelle SS396		1968	1968	8	6.5L	396	4 BBL Vin EG	R44XLS			0.9
Chevrolet	Chevy II		1966	1966	8	5.4L	327	CARB			41833	0.9
Chevrolet	Chevy II		1968	1968	8	5.4L	327	4 BBL Vin MK ML MM			41833	0.9
Chevrolet	Chevy II Nova		1966	1966	8	4.6L	283	2 BBL			41833	0.9
Chevrolet	Chevy II Nova		1967	1967	8	4.6L	283	2 BBL Vin PD PL			41833	0.9
Chevrolet	Chevy II Nova		1967	1967	8	5.4L	327	4 BBL Vin ZD ZE ZK			41833	0.9
Chevrolet	Chevy II Nova SS		1968	1968	8	5.7L	350	4 BBL Vin MS MU			41833	0.9
Chevrolet	Corvette		1966	1966	8	5.4L	327	4 BBL			41833	0.9
Chevrolet	Corvette		1966	1966	8	7.0L	427	4 BBL	R43XLS	AC4		0.9
Chevrolet	Corvette		1967	1968	8	5.4L	327	4 BBL Vin HO HP HE			41833	0.9

MAKE	MODEL	SERIES / BADGE	FROM	TO	CYLS	CAPACITY	ENGINE	ADDITIONAL INFORMATION	REGULAR	PLATINUM (RAPIDFIRE®)	DOUBLE PLATINUM	GAP (MM)#
Chevrolet	Corvette		1967	1967	8	7.0L	427	4 BBL Vin IL IM IQ IR	R43XLS	AC4		0.9
Chevrolet	Corvette		1968	1968	8	7.0L	427	4 BBL Vin IL IQ	R43XLS	AC4		0.9
Chevrolet	Corvette		1969	1969	8	5.7L	350	4 BBL Vin HY HZ			41833	0.9
Chevrolet	Corvette		1969	1969	8	7.0L	427	4 BBL Vin LM LL		AC4		1.0
Chevrolet	Corvette		1970	1970	8	5.7L	350	4 BBL Vin CTM CTN			41833	0.9
Chevrolet	Corvette		1971	1971	8	5.7L	350	4 BBL Vin CGZ CJK	R44TS			0.9
Chevrolet	Corvette		1971	1971	8	7.4L	454	4 BBL Vin CPJ CPW	R44TS			0.9
Chevrolet	Corvette		1987	1991	8	5.7L	350	F/I Vin 8		AC5		1.1
Chevrolet	Corvette		1987	1987	8	5.7L	350	F/I Vin 8	41629		41800	0.9
Chevrolet	Corvette		1997	2004	8	5.7L	350	F/I Vin G		AC6		1.1
Chevrolet	Corvette		2001	2002	8	5.7L	350	F/I Vin S (Z06)		AC6		1.1
Chevrolet	Corvette		2003	2003	8	5.7L	350	F/I Vin G			41805	1.0
Chevrolet	Corvette		2005	2007	8	6.0L	384	F/I Vin U		AC6	41805	1.0
Chevrolet	Corvette LT1		1993	1996	8	5.7L	350	F/I Vin P		AC14		1.5
Chevrolet	Corvette Z06		2003	2004	8	5.7L	350	F/I Vin S (Z06)		AC6		1.1
Chevrolet	Corvette Z06		2006	2006	8	7.0L	427	F/I Vin E (Z06)		AC6	41805	1.0
Chevrolet	Corvette ZR1		1990	1992	8	5.7L	350	F/I Vin J (ZR1)	41602		41800	1.0
Chevrolet	Corvette ZR1		1992	1995	8	5.7L	350	F/I Vin J (ZR1)			41963*	0.9
Chevrolet	El Camino		1966	1966	8	6.5L	396	4 BBL	R43XLS			0.9
Chevrolet	El Camino		1967	1967	8	6.5L	396	4 BBL Vin Y	R43XLS	AC4		0.9
Chevrolet	El Camino		1968	1968	8	5.0L	307	2 BBL Vin W			41833	0.9
Chevrolet	El Camino		1968	1968	8	6.5L	396	4 BBL Vin EF EL EU	R43XLS	AC4	41802	0.9
Chevrolet	El Camino		1968	1968	8	6.5L	396	4 BBL Vin EF EL EU	R44XLS	AC4	41802	0.9
Chevrolet	El Camino		1969	1969	8	5.0L	307	2 BBL Vin U			41833	0.9
Chevrolet	El Camino		1969	1969	8	6.5L	396	4 BBL Vin JA JE	R43XLS	AC4		0.9
Chevrolet	El Camino		1970	1970	8	5.0L	307	2 BBL Vin B			41833	0.9
Chevrolet	El Camino		1970	1970	8	6.5L	396	4 BBL	R43XLS		41802	0.9
Chevrolet	El Camino		1971	1971	8	5.7L	350	2 BBL Vin E	R44TS			0.9
Chevrolet	El Camino		1971	1971	8	6.6L	402	4 BBL Vin K	R44TS			0.9
Chevrolet	Impala		1966	1966	8	4.6L	283	2 BBL			41833	0.9
Chevrolet	Impala		1966	1966	8	5.4L	327	4 BBL			41833	0.9
Chevrolet	Impala		1967	1967	8	4.6L	283	2 BBL Vin GS GU GF GO			41833	0.9
Chevrolet	Impala		1967	1967	8	5.4L	327	4 BBL Vin HA HC			41833	0.9
Chevrolet	Impala		1968	1968	8	5.0L	307	2 BBL Vin DK DO DP DS			41833	0.9
Chevrolet	Impala		1968	1968	8	5.4L	327	4 BBL Vin HM HJ HL			41833	0.9
Chevrolet	Impala		1969	1969	8	5.4L	327	2 BBL Vin FJ FK FL			41833	0.9

MAKE	MODEL	SERIES / BADGE	FROM	TO	CYLS	CAPACITY	ENGINE	ADDITIONAL INFORMATION	REGULAR	PLATINUM (RAPIDFIRE®)	DOUBLE PLATINUM	GAP (MM)#
Chevrolet	Impala		1969	1969	8	5.7L	350	2 BBL Vin IL IM			41833	0.9
Chevrolet	Impala		1970	1970	8	5.7L	350	4 BBL Vin NQ NR NS NT			41833	0.9
Chevrolet	Impala		1971	1971	8	6.6L	402	4 BBL Vin CLB	R44TS			0.9
Chevrolet	Impala		2006	2007	6	3.5L	213	FLEX/FI Vin K		AC6		1.1
Chevrolet	Impala		2006	2007	6	3.5L	213	F/I Vin N		AC6		1.1
Chevrolet	Impala		2006	2006	6	3.9L	237	F/I Vin I		AC6		1.1
Chevrolet	Impala		2007	2007	6	3.9L		F/I Vin R		AC6		1.0
Chevrolet	Impala SS		1994	1996	8	5.7L	350	F/I Vin P		AC14		1.5
Chevrolet	Impala SS		2006	2007	8	5.3L	325	F/I Vin C (SS)		AC6	41805	1.0
Chevrolet	Monte Carlo		1971	1971	8	6.6L	400	2 BBL Vin LA LJ LK	R44TS			0.9
Chevrolet	Monte Carlo		1971	1971	8	6.6L	400	4 BBL Vin LL LB LP	R44TS			0.9
Chevrolet	Monte Carlo		1985	1985	8	5.0L	305	4 BBL Vin G (SS)	R44TS			1.1
Chevrolet	Monte Carlo SS		2006	2006	8	5.3L	325	F/I Vin C (SS)			41805	1.0
Chevrolet	Silverado 1500		2005	2006	8	4.8L	294	F/I Vin V			41805	1.0
Chevrolet	Silverado 1500		2005	2006	8	5.3L	323	F/I Vin T			41805	1.0
Chevrolet	Silverado 1500		2006	2006	8	5.3L	323	FLEX/FI Vin Z			41805	1.0
Chevrolet	Silverado 1500		2006	2006	8	5.3L	323	F/I Vin B			41805	1.0
Chevrolet	Silverado 1500		2006	2006	8	6.0L	364	F/I Vin N			41805	1.0
Chevrolet	Silverado 1500 HD		2005	2006	8	6.0L	364	F/I Vin U			41805	1.0
Chevrolet	Silverado 2500		1999	2000	8	5.3L	323	F/I Vin T			41805	1.0
Chevrolet	Silverado 3500		2003	2005	8	6.0L	364	CNG/FI Vin U			41805	1.0
Chevrolet	Silverado 3500		2003	2006	8	6.0L	364	F/I Vin U			41805	1.0
Chevrolet	Silverado SS		2006	2006	8	6.0L	364	F/I Vin N (SS)			41805	1.0
Chevrolet	SSR		2005	2006	8	6.0L	364	F/I Vin H			41805	1.0
CHRYSLER												
Chrysler	300C	5.7 HEMI V8	11/05	02/08	8	5.7L	EZB				41834*	1.1
Chrysler	300C	5.7 HEMI V8	2009	01/12	8	5.7L	EZB				41835*	1.1
Chrysler	Centura	KB	1975	1977	4	2.0L			R43XLS	AC4	41802	0.8
Chrysler	Centura	KB	1975	1976	6	3.5L			R43XLS	AC4	41802	0.8
Chrysler	Centura	KB	1975	1977	6	4.0L			R43XLS	AC4	41802	0.8
Chrysler	Centura	KC	1977	1978	6	4.0L			R43XLS	AC4	41802	0.8
Chrysler	Charger	VH	1971	1973	6	4.0L	245		43XLS	AC4		0.8
Chrysler	Charger	VH	1971	1973	6	4.3L	265	Not E37/E38/E49	43XLS	AC4		0.8
Chrysler	Charger	VH	1971	1973	8	5.2L	318		43XLS	AC4		0.8
Chrysler	Charger	VJ	1973	1975	6	3.5L	215		43XLS	AC4		0.8
Chrysler	Charger	VJ	1973	1975	6	4.0L	245		43XLS	AC4		0.8
Chrysler	Charger	VJ	1973	1975	6	4.3L	265	Not E37/E38/E49	43XLS	AC4		0.8
Chrysler	Charger	VJ	1973	1975	8	5.2L	318		43XLS	AC4		0.8
Chrysler	Charger	VJ	1973	1975	8	5.9L	360		43XLS	AC4		0.8

MAKE	MODEL	SERIES / BADGE	FROM	TO	CYLS	CAPACITY	ENGINE	ADDITIONAL INFORMATION	REGULAR	PLATINUM (RAPIDFIRE®)	DOUBLE PLATINUM	GAP (MM)#
Chrysler	Charger	VK	1975	1976	6	3.5L	215		43XLS	AC4		0.8
Chrysler	Charger	VK	1975	1976	6	4.0L	245		43XLS	AC4		0.8
Chrysler	Charger	VK	1975	1976	6	4.3L	265		43XLS	AC4		0.8
Chrysler	Charger	VK	1975	1976	8	5.2L	318		43XLS	AC4		0.8
Chrysler	Charger	VK	1975	1976	8	5.9L	360		43XLS	AC4		0.8
Chrysler	Charger	CL	1976	1978	6	4.0L	245		43XLS	AC4		0.8
Chrysler	Charger	CL	1976	1978	6	4.3L	265		43XLS	AC4		0.8
Chrysler	Charger	CL	1976	1978	8	5.2L	318		43XLS	AC4		0.8
Chrysler	Crossfire		12/03	2007	6	3.2L	M11294		41629		41800	1.1
Chrysler	Crossfire		04/04	2007	6	3.2L	Mercedes Engine		41602	AC5	41801	1.0
Chrysler	Grand Voyager	GS - LE, LE LTD	06/97	04/01	6	3.3L	EGA				41802	1.1
Chrysler	Grand Voyager	GS - SE	10/97	04/01	6	3.3L	EGA				41802	1.1
Chrysler	Grand Voyager	GS - LE	02/00	04/01	6	3.3L	EGA				41802	1.1
Chrysler	Grand Voyager	GS - LX	02/00	04/01	6	3.3L	EGA				41802	1.1
Chrysler	Grand Voyager	RG - Limited	05/01	03/08	6	3.3L	EGA				41834*	1.3
Chrysler	Grand Voyager	RG - LX	05/01	03/08	6	3.3L	EGA				41834*	1.3
Chrysler	Grand Voyager	RG - SE	05/01	03/08	6	3.3L	EGA				41834*	1.3
Chrysler	Grand Voyager	RG - Limited	03/02	03/06	6	3.3L	EGA				41834*	1.3
Chrysler	Neon	JA	07/96	08/99	4	2.0L	S4RE		41602	AC5	41801	0.8
Chrysler	Neon	JB	09/99	07/02	4	2.0L	S4RE		41602	AC5	41801	0.8
Chrysler	PT Cruiser	PT	07/00	2002	4	2.0L	ECC				41834*	1.1
Chrysler	PT Cruiser	PG	2002	11/04	4	2.0L	ECC				41834*	1.1
Chrysler	PT Cruiser	PG - Classic, Limited	12/04	11/05	4	2.4L	EDZ				41834*	1.2
Chrysler	PT Cruiser	PG - Route 66	12/05	2008	4	2.4L	EDZ				41834*	1.1
Chrysler	PT Cruiser	PG - Route 66, Limited, Touring	12/05	07/09	4	2.4L	EDZ				41834*	1.1
Chrysler	PT Cruiser	PG - Limited, Touring	06/06	07/09	4	2.4L	EDZ				41834*	1.1
Chrysler	PT Cruiser	PG	2009	2010	4	2.4L	EDZ				41834*	1.1
Chrysler	PT Cruiser	PG - Touring	2009	2010	4	2.4L	EDZ				41834*	1.1
Chrysler	Valiant	AP5	1963	1965	6	3.7L	225		43XLS	AC4		0.8
Chrysler	Valiant	AP6	1965	1966	6	3.7L	225		43XLS	AC4		0.8
Chrysler	Valiant	VC	1966	1967	6	3.7L	225		43XLS	AC4		0.8
Chrysler	Valiant	VE	1967	1969	6	3.7L	225		43XLS	AC4		0.8
Chrysler	Valiant	VF	1969	1970	6	3.7L	225		43XLS	AC4		0.8
Chrysler	Valiant	VF	1969	1970	6	4.0L	245		43XLS	AC4		0.8
Chrysler	Valiant	VF	1969	1970	8	5.2L	318		43XLS	AC4		0.8
Chrysler	Valiant	VG	1970	1971	6	3.5L	215		43XLS	AC4		0.8
Chrysler	Valiant	VG	1970	1971	6	3.7L	225		43XLS	AC4		0.8
Chrysler	Valiant	VG	1970	1971	6	4.0L	245		43XLS	AC4		0.8
Chrysler	Valiant	VG	1970	1971	8	5.2L	318		43XLS	AC4		0.8
Chrysler	Valiant	VH	1971	1973	6	3.5L	215		43XLS	AC4		0.8

MAKE	MODEL	SERIES / BADGE	FROM	TO	CYLS	CAPACITY	ENGINE	ADDITIONAL INFORMATION	REGULAR	PLATINUM (RAPIDFIRE®)	DOUBLE PLATINUM	GAP (MM)#
Chrysler	Valiant	VH	1971	1973	6	4.0L	245		43XLS	AC4		0.8
Chrysler	Valiant	VH	1971	1973	6	4.3L	265		43XLS	AC4		0.8
Chrysler	Valiant	VH	1971	1973	8	5.2L	318		43XLS	AC4		0.8
Chrysler	Valiant	VJ	1973	1975	6	3.5L	215		43XLS	AC4		0.8
Chrysler	Valiant	VJ	1973	1975	6	4.0L	245		43XLS	AC4		0.8
Chrysler	Valiant	VJ	1973	1975	6	4.3L	265		43XLS	AC4		0.8
Chrysler	Valiant	VJ	1973	1975	8	5.2L	318		43XLS	AC4		0.8
Chrysler	Valiant	VK	1975	1976	6	3.5L	215		43XLS	AC4		0.8
Chrysler	Valiant	VK	1975	1976	6	4.0L	245		43XLS	AC4		0.8
Chrysler	Valiant	VK	1975	1976	6	4.3L	265		43XLS	AC4		0.8
Chrysler	Valiant	VK	1975	1976	8	5.2L	318		43XLS	AC4		0.8
Chrysler	Valiant	VK	1975	1976	8	5.9L	360		43XLS	AC4		0.8
Chrysler	Valiant	CL	1976	1978	6	4.0L	245		43XLS	AC4		0.8
Chrysler	Valiant	CL	1976	1979	6	4.3L	265		43XLS	AC4		0.8
Chrysler	Valiant	CM	1978	1981	6	4.0L	245		43XLS	AC4		0.8
Chrysler	Valiant	CM	1978	1981	6	4.3L	265		43XLS	AC4		0.8
Chrysler	Voyager	RG - SE	05/01	03/08	6	3.3L	EGA				41834*	1.2
CITROEN												
Citroen	AX	GTi	01/91	1993	4	1.4L	TU3FJ2		41602	AC5	41801	0.8
Citroen	AX	GTi	01/91	1993	4	1.4L	TU3FMC		41629		41800	0.8
Citroen	Berlingo Van		07/99	06/10	4	1.4L	TU3JP		41602	AC5	41801	0.9
Citroen	BX16V		10/89	1994	4	1.9L	XU9J4	DOHC	FR1LS			1.0
Citroen	BX19TRi		02/87	1990	4	1.9L	XU9J1/A	SOHC	41602	AC5	41801	0.7
Citroen	BX19TZi		04/90	1994	4	1.9L	XU9JA	SOHC	41602	AC5	41801	0.8
Citroen	C2		2003	2007	4	1.6L	TU5JP4				41835*	0.9
Citroen	C3		12/02	03/09	4	1.4L	TU3JP	SOHC	41602	AC5	41801	0.9
Citroen	C3		09/03	08/10	4	1.6L	TU5JP4				41835*	0.9
Citroen	C4		04/05	02/09	4	1.6L	TU5JP4				41835*	0.9
Citroen	GS1015		1974	1979	4	1.0L		With 3/4" Reach	R42XLS	AC4	41804	0.8
Citroen	GS1220 Club		1978	1979	4	1.2L			R42XLS	AC4	41804	0.8
Citroen	Xantia		03/93	05/95	4	2.0L	XU10J2C	8V			41825	0.8
Citroen	Xantia		09/94	1998	4	2.0L	XU10J2C	SOHC	41629		41800	0.9
Citroen	Xantia		06/95	03/98	4	2.0L	XU10J2C	8V	41629		41800	0.9
Citroen	Xantia		01/96	1998	4	2.0L	XU10	DOHC	41629		41800	0.8
Citroen	Xantia		11/96	1998	4	2.0L		Turbo	41602	AC5	41801	0.9
Citroen	Xantia		03/98	06/01	4	2.0L	XU10J4R	16V DOHC	41602	AC5	41801	0.9
Citroen	Xantia		08/98	2001	6	3.0L	ES9J4		41602	AC5	41801	1.0
Citroen	XM	AG	1990	1997	6	3.0L	SKZ				41825	1.0
Citroen	XM	AL	1990	1997	6	3.0L	SKZ				41825	1.0
Citroen	Xsara		07/98	2000	4	1.8L	XU7JP	SOHC	41602	AC5	41801	0.9
Citroen	Xsara		07/98	2001	4	1.8L	XU7JP4	DOHC	41602	AC5	41801	0.9
Citroen	Xsara		09/98	04/05	4	2.0L	XU10J4RS		41602	AC5	41801	0.9
Citroen	Xsara		02/00	04/05	4	1.6L	TU5JP	SOHC	41602	AC5	41801	0.9
Citroen	Xsara		02/01	04/05	4	1.6L	TU5JP5				41835*	0.9
Citroen	Xsara		02/01	04/05	4	2.0L	EW10J4		41602	AC5	41801	0.9
DAEWOO												
Daewoo	1.5i		1994	1997	4	1.5L	G15MF	SOHC	R42XLS	AC4	41804	0.8

MAKE	MODEL	SERIES / BADGE	FROM	TO	CYLS	CAPACITY	ENGINE	ADDITIONAL INFORMATION	REGULAR	PLATINUM (RAPIDFIRE®)	DOUBLE PLATINUM	GAP (MM)#
Daewoo	Cielo		10/95	1997	4	1.5L	LG15MF	DOHC	41602	AC5	41801	1.1
Daewoo	Cielo	1.5i	10/95	1998	4	1.5L	G15MF	SOHC	R42XLS	AC4	41804	0.8
Daewoo	Espero	CD	03/95	1997	4	2.0L	C20LE		R42XLS	AC4	41804	0.8
Daewoo	Kalos	T200	03/03	2005	4	1.5L	F15S3	SOHC	R42XLS	AC4	41804	0.8
Daewoo	Korando		02/98	2002	6	3.2L	M162		41629		41800	0.8
Daewoo	Lacetti	J200	08/03	2004	4	1.8L	18SED	DOHC	41629		41800	0.8
Daewoo	Lanos		09/97	2003	4	1.5L	A15		R42XLS	AC4	41804	0.8
Daewoo	Lanos		09/97	2003	4	1.6L	A16		41602	AC5	41801	1.1
Daewoo	Leganza		07/97	1999	4	2.0L	C20SED		41629		41800	1.1
Daewoo	Leganza		04/99	2003	4	2.2L	X22SED				41806	1.1
Daewoo	Load Runner		07/96	1998	4	1.8L	G15MF		R42XLS	AC4	41804	0.8
Daewoo	Matiz	KL	10/99	2004	3	0.8L	F8CV		R43XLS	AC4	41802	1.1
Daewoo	Musso		07/98	2002	6	3.2L	M162		41629		41800	0.8
Daewoo	Nubira	J100	1997	2006	4	2.0L	X20SED		41602	AC5	41801	1.1
Daewoo	Nubira	J150	1997	2006	4	2.0L	X20SED		41602	AC5	41801	1.1
Daewoo	Nubira	J100	06/97	2000	4	1.6L	A16		41602	AC5	41801	1.1
Daewoo	Tacuma		11/00	2004	4	2.0L	T20SED		41602	AC5	41801	0.8
DAIHATSU												
Daihatsu	Applause	A101	1989	1999	4	1.6L	HDE		41629		41800	1.1
Daihatsu	Applause	A102	1989	1999	4	1.6L	HDE		41629		41800	1.1
Daihatsu	Applause	A103	10/97	1999	4	1.6L	HDE1		41602	AC5	41801	1.1
Daihatsu	Centro		1995	1999	3	0.660L			FR1LS			0.9
Daihatsu	Charade	G10	04/80	05/87	3	1.0L	NS		R43XLS	AC4	41802	0.9
Daihatsu	Charade	G11	03/84	1988	3	1.0L	CB		R43XLS	AC4	41802	0.9
Daihatsu	Charade	G100	06/87	10/88	3	1.0L	CB61	Turbo	R42XLS	AC4	41804	0.9
Daihatsu	Charade	G102	1988	1993	4	1.3L	HCE		41629		41800	1.1
Daihatsu	Charade	G202	1993	03/98	3	1.0L	CB24		R43XLS	AC4	41802	0.9
Daihatsu	Charade	G200	06/93	1998	4	1.3L	HCE		41629		41800	1.1
Daihatsu	Charade	G203	08/94	2000	4	1.5L	HEE		41602	AC5	41801	1.1
Daihatsu	Charade	L251S	06/03	2005	3	1.0L	EJDE		41629		41800	1.1
Daihatsu	Copen	L880	10/03	2005	3	0.660L	JBDET	Turbo	41602	AC5	41801	0.8
Daihatsu	Cuore	L701	07/00	2003	3	1.0L	EJDE		41629		41800	1.1
Daihatsu	Delta		1978	1978	4	1.5L			R43XLS	AC4	41802	0.8
Daihatsu	Delta		1979	1984	4	2.0L	5R		R43XLS	AC4	41802	0.8
Daihatsu	Delta		1984	1987	4	2.0L	3Y		R43XLS	AC4	41802	0.8
Daihatsu	Delta		1987	1989	4	2.2L	4Y		R43XLS	AC4	41802	0.8
Daihatsu	F20		1981	1984	4	1.6L	12R		R43XLS	AC4	41802	0.8
Daihatsu	F25		1983	1984	4	1.6L	12R		R43XLS	AC4	41802	0.8
Daihatsu	Feroza	F300	1988	1997	4	1.6L	HDE		41602	AC5	41801	1.1
Daihatsu	Feroza	F310	1992	1997	4	1.6L	HDE		41602	AC5	41801	1.1
Daihatsu	G100		05/87	07/93	3	1.0L			43XLS	AC4		0.9
Daihatsu	Handivan	L55	1981	1982	2	0.547L	AB		R42XLS	AC4	41804	0.8
Daihatsu	Handivan	L60	1982	1986	2	0.617L	AD		R42XLS	AC4	41804	0.8
Daihatsu	Handivan	L80	03/86	1990	3	0.846L	ED		R42XLS	AC4	41804	0.8
Daihatsu	Handivan	L701	03/99	2002	3	1.0L	EJDE		41629		41800	1.1
Daihatsu	Hi Jet	S60	01/76	1979	2	0.547L	AB		R43XLS	AC4	41802	0.8
Daihatsu	Hi Jet	S65	1979	1982	2	0.547L	AB		R42XLS	AC4	41804	0.8
Daihatsu	Hi Jet	S75	1984	1986	3	1.0L	CB		R43XLS	AC4	41802	0.8

MAKE	MODEL	SERIES / BADGE	FROM	TO	CYLS	CAPACITY	ENGINE	ADDITIONAL INFORMATION	REGULAR	PLATINUM (RAPIDFIRE®)	DOUBLE PLATINUM	GAP (MM)#
Daihatsu	Hi Jet	S76	1984	1986	3	1.0L	CB		R43XLS	AC4	41802	0.8
Daihatsu	Hi Jet	S85	1984	1994	3	1.0L	CB		R43XLS	AC4	41802	0.8
Daihatsu	Hi Jet	S85T	1987	1988	3	1.0L	CB		R43XLS	AC4	41802	0.8
Daihatsu	Mira	L201	11/90	1992	3	0.847L	ED		R42XLS	AC4	41804	0.9
Daihatsu	Move	L601	02/97	1999	3	0.850L	ED20		R42XLS	AC4	41804	1.1
Daihatsu	Pyzar	G303	02/97	1998	3	1.5L	HEEG		41602	AC5	41801	1.1
Daihatsu	Pyzar	G301	09/98	2000	3	1.6L	HDEP		41602	AC5	41801	1.1
Daihatsu	Rocky		06/84	1989	4	2.0L	3YC		R43XLS	AC4	41802	1.1
Daihatsu	Rocky		10/87	1989	4	2.0L	3YE		R43XLS	AC4	41802	0.8
Daihatsu	Sirion	M100	07/98	2005	3	1.0L	EJDE		41629		41800	1.1
Daihatsu	Sirion	M101	09/00	02/05	4	1.3L	K3VE2		41629		41800	1.1
Daihatsu	Terios	J100	05/97	2000	4	1.3L	HCEJ	SOHC	41602	AC5	41801	1.0
Daihatsu	Terios	J102	10/00	2005	4	1.3L	K3VE	DOHC	41602	AC5	41801	1.1
Daihatsu	YRV	M201	07/01	01/05	4	1.3L	K3VE		41602	AC5	41801	1.1
DAIMLER												
Daimler	Double Six		07/74	1982	12	5.3L			R43XLS	AC4	41802	0.8
Daimler	Double Six		01/86	1988	12	5.3L	7P		R42LTS		41810	0.8
Daimler	Double Six	HE	02/92	1998	12	6.0L	8E		R42LTS		41810	0.8
Daimler	Sedan Six		1987	1989	6	3.6L	9DF		41602	AC5	41801	0.8
Daimler	Sovereign		07/74	1982	6	4.2L			R43XLS	AC4	41802	0.8
Daimler	Sovereign		1983	1987	6	4.2L	8L		R43XLS	AC4	41802	0.8
Daimler	Sovereign		02/86	1989	12	5.3L	7P		R42LTS		41810	0.6
Daimler	Sovereign		03/87	1989	6	3.6L	9DP		41602	AC5	41801	0.8
Daimler	Sovereign		10/92	1994	6	3.2L	9BP		41602	AC5	41801	1.3
Daimler	Sovereign		10/98	2000	8	3.2L	AJ6		41602	AC5	41801	1.3
Daimler	V8		10/97	2003	8	4.0L	BC		41602	AC5	41801	1.3
Daimler	V8		10/97	2003	8	4.0L	BC	Supercharged	41602	AC5	41801	1.3
DODGE												
Dodge	Avenger	JS - SXT	08/07	06/10	6	2.7L	2.7				41834*	1.3
Dodge	Caliber		08/06	08/10	4	1.8L		110kW DOHC			41806	1.1
Dodge	Caliber		08/06	on	4	2.0L		115kW DOHC			41806	1.1
Dodge	Caliber		10/06	08/10	4	2.4L		127kW DOHC			41806	1.1
Dodge	CB300		1976	1977	8	6.6L	400	CARB Vin J			41833	0.9
Dodge	CB300		1977	1979	8	7.2L		CARB Vin D			41833	0.9
Dodge	Challenger		1970	1971	8	6.3L		4 BBL Vin N			41833	0.8
Dodge	Challenger		2008	2009	8	6.1L	370	F/I Vin W (SRT-8)			41834*	1.1
Dodge	Challenger		2009	2010	8	5.7L	345	F/I Vin T			41834*	1.1
Dodge	Challenger		2010	2010	8	6.1L		F/I Vin W			41834*	1.1
Dodge	Challenger		2011	2011	8	5.7L	345	F/I Vin T			41835*	1.1
Dodge	Challenger R/T		1970	1971	8	7.2L		3x2 BBL Vin V (R/T)			41833	0.9
Dodge	Challenger R/T		1970	1970	8	7.2L		4 BBL Vin U (R/T)			41833	0.9
Dodge	Charger		1966	1966	8	5.2L		2 BBL Vin F			41833	0.9
Dodge	Charger		1966	1966	8	5.9L		2 BBL Vin E			41833	0.9
Dodge	Charger		1966	1969	8	6.3L	383	4 BBL Vin H			41833	0.9

MAKE	MODEL	SERIES / BADGE	FROM	TO	CYLS	CAPACITY	ENGINE	ADDITIONAL INFORMATION	REGULAR	PLATINUM (RAPIDFIRE®)	DOUBLE PLATINUM	GAP (MM)#
Dodge	Charger		1966	1966	8	7.0L	426	2x4 BBL Vin J			41802	0.9
Dodge	Charger		1966	1966	8	7.2L		CARB			41833	0.9
Dodge	Charger		1967	1967	8	7.2L		4 BBL Vin L			41833	0.9
Dodge	Charger		1967	1967	8	7.2L		CARB Vin K (R/T)			41833	0.9
Dodge	Charger		1970	1971	8	6.3L	383	4 BBL Vin N			41833	0.9
Dodge	Charger		1970	1974	8	7.2L		4 BBL Vin U			41833	0.9
Dodge	Charger		1970	1970	8	7.2L		4 BBL Vin T			41833	0.9
Dodge	Charger		1972	1976	8	6.6L	400	2 BBL Vin M			41833	0.9
Dodge	Charger		1972	1978	8	6.6L	400	4 BBL Vin P			41833	0.9
Dodge	Charger		1972	1972	8	7.2L		3x2 BBL Vin V			41833	0.9
Dodge	Charger		1974	1978	8	6.6L	400	4 BBL Vin N			41833	0.9
Dodge	Charger		1975	1976	8	6.6L	400	CARB Vin P			41833	0.9
Dodge	Charger		2006	2008	8	5.7L	345	F/I Vin H (R/T)			41834*	1.1
Dodge	Charger		2006	2009	8	6.1L	370	F/I Vin W (SRT8)			41834*	1.1
Dodge	Charger		2009	2009	8	5.7L	345	F/I Vin T			41834*	1.1
Dodge	Charger		2010	2010	6	2.7L		F/I Vin D/ EER			41834*	1.2
Dodge	Charger		2010	2010	8	5.7L	345	F/I Vin T/ EZD			41834*	1.1
Dodge	Charger		2010	2010	8	6.1L		F/I Vin W			41834*	1.1
Dodge	Charger		2011	2011	8	5.7L	345	F/I Vin T			41835*	1.1
Dodge	Charger 500		1968	1968	8	7.2L		4 BBL Vin K			41833	0.9
Dodge	Charger 500		1969	1969	8	7.2L		4 BBL Vin L			41833	0.9
Dodge	Charger R/T		1970	1971	8	7.2L		3x2 BBL Vin V			41833	0.9
Dodge	Coronet		1966	1966	8	7.0L	426	2x4 BBL Vin J			41802	0.9
Dodge	Dakota		1996	1996	8	5.2L			41629		41800	0.9
Dodge	Dakota		1997	1998	8	5.2L					41806	1.0
Dodge	Dakota		1999	2005	8	4.7L	N				41806	1.0
Dodge	Dakota		1999	2003	8	5.9L					41806	1.0
Dodge	Dart		1966	1966	8	6.3L	383	CARB			41833	0.9
Dodge	Dart GTS		1968	1969	8	6.3L	383	4 BBL Vin H (GTS)			41833	0.9
Dodge	Durango		1999	2005	8	4.7L					41806	1.0
Dodge	Durango		1999	2003	8	5.9L					41806	1.0
Dodge	Journey	JC - R/T, SXT	09/08	01/12	6	2.7L	2.7				41834*	1.3
Dodge	Journey	JC - R/T	2009	01/12	6	2.7L	2.7				41834*	1.3
Dodge	Journey	JC - SXT	2009	01/12	6	2.7L	2.7				41834*	1.3
Dodge	Magnum		1978	1978	8	6.6L	400	4 BBL Vin N			41833	0.9
Dodge	Magnum		1978	1978	8	6.6L	400	4 BBL Vin P			41833	0.9
Dodge	Nitro	KA - SX, SX-R	06/07	09/10	6	3.7L	EKG				41806	1.1
Dodge	Nitro	KA - SXT	06/07	06/12	6	3.7L	EKG				41806	1.1
Dodge	Nitro	KA - SX	09/10	2014	6	3.7L	EKG				41806	1.1
Dodge	Ram		1996	2004	10	8.0L					41806	1.1
Dodge	Ram		1997	2003	8	5.2L					41806	1.0
Dodge	Ram		1997	1997	8	5.9L					41806	0.9

MAKE	MODEL	SERIES / BADGE	FROM	TO	CYLS	CAPACITY	ENGINE	ADDITIONAL INFORMATION	REGULAR	PLATINUM (RAPIDFIRE®)	DOUBLE PLATINUM	GAP (MM)#
Dodge	Ram		1998	2003	8	5.9L					41806	1.0
Dodge	Ramcharger		1974	1978	8	6.6L	400	2 BBL Vin J			41833	0.9
Dodge	Ramcharger		1974	1978	8	7.2L		4 BBL Vin D			41833	0.9
Dodge	Viper		1996	2002	10	8.0L	E				41833	0.9
Dodge	Viper		2008	2010	10	8.4L	515	8.4L F/I Vin Z			41834*	0.9
EUNOS												
Eunos	500	CA	06/96	1999	6	2.0L	KFZE				41800	1.1
Eunos	800	TA	06/96	1998	6	2.5L	KLZE				41806	1.1
Eunos	30X	EC	06/96	1997	6	1.8L	K8ZE		41602	AC5	41801	1.1
Eunos	800M	TA	06/96	2000	6	2.3L	KJ	Miller Engine	41602	AC5	41801	1.1
FIAT												
Fiat	124		1967	1972	4	1.2L		DOHC	R42XLS	AC4	41804	0.8
Fiat	124		1967	1972	4	1.4L		DOHC	R42XLS	AC4	41804	0.8
Fiat	124		1970	1972	4	1.6L		DOHC	R42XLS	AC4	41804	0.8
Fiat	124		1973	1976	4	1.8L		DOHC	R42XLS	AC4	41804	0.8
Fiat	125		1968	1973	6	1.6L		DOHC	R42XLS	AC4	41804	0.8
Fiat	127		1975	1977	4	0.9L			R42XLS	AC4	41804	0.8
Fiat	128		1974	1976	4	1.1L			R42XLS	AC4	41804	0.8
Fiat	128		1976	1981	4	1.3L			R42XLS	AC4	41804	0.8
Fiat	130		1972	1976	6	3.2L			R42XLS	AC4	41804	0.8
Fiat	132		1973	1979	4	1.8L		DOHC	R42XLS	AC4	41804	0.8
Fiat	132		1979	1982	4	2.0L		DOHC	R42XLS	AC4	41804	0.8
Fiat	1300		1976	1981	4	1.3L			R42XLS	AC4	41804	0.8
Fiat	1500		1962	1968	4	1.5L			R42XLS	AC4	41804	0.8
Fiat	1800		1960	1967	6	1.8L			R42XLS	AC4	41804	0.8
Fiat	2300		1961	1967	6	2.3L			R42XLS	AC4	41804	0.8
Fiat	131 Mirafiori		1975	1982	4	1.6L			R42XLS	AC4	41804	0.8
Fiat	131 Super Mirafiori		1978	1982	4	1.6L			R42XLS	AC4	41804	0.8
Fiat	1600S		1963	1963	4	1.6L			R42XLS	AC4	41804	0.8
Fiat	850 Coupe		1966	1971	4	0.9L			R42XLS	AC4	41804	0.8
Fiat	850 Special		1966	1971	4	0.9L			R42XLS	AC4	41804	0.8
Fiat	850 Spider		1966	1971	4	0.9L			R42XLS	AC4	41804	0.8
Fiat	850 Sport		1966	1971	4	0.9L			R42XLS	AC4	41804	0.8
Fiat	Argenta		03/83	1985	4	2.0L		DOHC	R42XLS	AC4	41804	0.8
Fiat	Croma		03/88	1989	4	2.0L	834AB		R42XLS	AC4	41804	0.7
Fiat	Regatta	100S	1984	1989	4	1.6L			R42XLS	AC4	41804	0.8
Fiat	Regatta	85S	1984	1989	4	1.5L			R42XLS	AC4	41804	0.8
Fiat	X1/9		05/78	1981	4	1.3L			R42XLS	AC4	41804	0.8
Fiat	X1/9		08/81	1989	4	1.5L			R42XLS	AC4	41804	0.8
FORD												
Ford	Bronco		1981	1984	6	4.1L			43XLS	AC4		0.8
Ford	Bronco		03/81	1984	8	4.9L	302	Windsor	R43XLS	AC4		0.8
Ford	Bronco		03/81	1985	8	5.8L	351	Cleveland	R44TS			1.0
Ford	Capri	MKI	1969	1973	4	1.3L			42XLS			0.8
Ford	Capri	MKI	1969	1974	4	1.6L			42XLS			0.8
Ford	Capri	MKI	02/70	1973	6	3.0L			R42XLS	AC4	41804	0.8
Ford	Capri	SA	1989	1990	4	1.6L	B6T	Turbo	41602	AC5	41801	1.1

MAKE	MODEL	SERIES / BADGE	FROM	TO	CYLS	CAPACITY	ENGINE	ADDITIONAL INFORMATION	REGULAR	PLATINUM (RAPIDFIRE®)	DOUBLE PLATINUM	GAP (MM)#
Ford	Capri	SA	10/89	1990	4	1.6L	B6		R43XLS	AC4	41802	1.1
Ford	Capri	SB	1990	1992	4	1.6L	B6		R43XLS	AC4	41802	1.1
Ford	Capri	SB	1990	1992	4	1.6L	B6T	Turbo	41602	AC5	41801	1.1
Ford	Capri	SC	1992	1993	4	1.6L	B6		FR3LS		41800	1.1
Ford	Capri	SC	1992	1993	4	1.6L	B6T	Turbo	41602	AC5	41801	1.1
Ford	Capri	SE	1993	1995	4	1.6L	B6		FR3LS		41800	1.1
Ford	Capri	SE	1993	1994	4	1.6L	B6T	Turbo	41602	AC5	41801	1.1
Ford	Corsair	UA	11/89	1992	4	2.0L	CA20E	Exhaust	FR3LS		41800	1.1
Ford	Corsair	UA	11/89	1992	4	2.0L	CA20E	Inlet	41602	AC5	41801	1.1
Ford	Corsair	UA	11/89	1992	4	2.4L	KA24E				41806	1.1
Ford	Cortina	MKI	1962	1966	4	1.6L			R42XLS	AC4	41804	0.8
Ford	Cortina	MKII	1967	1970	4	1.6L			R42XLS	AC4	41804	0.8
Ford	Cortina	TC	1972	1974	4	1.6L			R42XLS	AC4	41804	0.8
Ford	Cortina	TD	1972	1976	6	3.3L		Iron Head	R44TS			0.9
Ford	Cortina	TD	1972	1976	6	4.1L		Iron Head	R44TS			0.9
Ford	Cortina	TD	1976	1977	6	3.3L		Alloy Head	43XLS	AC4		0.9
Ford	Cortina	TD	1976	1977	6	4.1L		Alloy Head	43XLS	AC4		0.9
Ford	Cortina	TE	1977	1980	6	3.3L		Iron Head	R44TS			0.9
Ford	Cortina	TE	1977	1980	6	4.1L		Iron Head	R44TS			0.9
Ford	Cortina	TE	1980	1980	6	3.3L		Alloy Head	43XLS	AC4		0.9
Ford	Cortina	TE	1980	1980	6	4.1L		Alloy Head	43XLS	AC4		0.9
Ford	Cortina	TF	1980	1982	6	3.3L		Iron Head	R44TS			0.9
Ford	Cortina	TF	1980	1982	6	3.3L		Alloy Head	43XLS	AC4		0.9
Ford	Cortina	TF	1980	1982	6	4.1L		Iron Head	R44TS			0.9
Ford	Cortina	TF	1980	1982	6	4.1L		Alloy Head	43XLS	AC4		0.9
Ford	Cougar	SV	1999	2002	6	2.5L	LCBC		R42LTS		41810	1.2
Ford	Cougar	SX	1999	2002	6	2.5L	LCBC		R42LTS		41810	1.2
Ford	Courier		1982	1985	4	2.0L	MA		43XLS	AC4		0.8
Ford	Courier	PC	1985	1988	4	2.0L	FE		R43XLS	AC4		0.8
Ford	Courier		1987	1982	4	1.8L	VC		43XLS	AC4		0.8
Ford	Courier	PC	05/87	1992	4	2.6L	AM	CARB	42XLS			0.8
Ford	Courier	PC	1988	1993	4	2.2L	F2	CARB	R43XLS	AC4		0.8
Ford	Courier	PC	1991	1996	4	2.6L	G6	EFI			41967*	1.1
Ford	Courier	PD	1996	1999	4	2.6L	G6	EFI			41967*	1.1
Ford	Courier	PE	1999	2002	4	2.6L	G6	EFI			41806	1.1
Ford	Courier	PG	11/02	2004	4	2.6L	G6	EFI			41806	1.1
Ford	Courier	PH	2004	2007	4	2.6L	G6	EFI			41806	1.1
Ford	Courier	PH	02/05	2006	6	4.0L			R44LTS6		41942	1.4
Ford	Econovan	SGMB	06/79	1984	4	1.6L	NA		R43XLS	AC4		0.8
Ford	Econovan	SGMD	1984	1997	4	1.8L	F8		R43XLS	AC4		0.8
Ford	Econovan	SGME	1984	1997	4	2.0L	FE		R43XLS	AC4		0.8
Ford	Econovan	JG	1997	2000	4	2.0L	FE		R43XLS	AC4		0.8
Ford	Econovan	JH	2000	2006	4	2.0L	FE		R43XLS	AC4		0.8
Ford	Econovan	JH	07/03	07/06	4	1.8L	F8E	EFI	41629		41800	1.1
Ford	Econovan	JH	07/03	07/06	4	2.0L	FEE	EFI	41629		41800	1.1
Ford	Escape	BA	02/01	03/03	6	3.0L	AJ		R42LTS		41963*	1.3
Ford	Escape	ZA	04/03	01/04	6	3.0L	AJ		R42LTS		41963*	1.3
Ford	Escape	ZB	01/04	2006	4	2.3L	L3		R42LTS		41963*	1.3

MAKE	MODEL	SERIES / BADGE	FROM	TO	CYLS	CAPACITY	ENGINE	ADDITIONAL INFORMATION	REGULAR	PLATINUM (RAPIDFIRE®)	DOUBLE PLATINUM	GAP (MM)#
Ford	Escape	ZB	01/04	2006	6	3.0L	AJ		R42LTS		41963*	1.3
Ford	Escape	ZC	2006	2008	4	2.3L	I3MZR				41814	1.3
Ford	Escape	ZC	2006	2008	6	3.0L	AJ				41963*	1.4
Ford	Escape	ZD	2008	01/12	4	2.3L	I3MZR				41814	1.3
Ford	Escort	MKI	1968	1975	4	1.1L			R42XLS	AC4	41804	0.8
Ford	Escort	MKI	1968	1975	4	1.3L			R42XLS	AC4	41804	0.8
Ford	Escort	MKII	06/75	1981	4	1.6L			R42XLS	AC4	41804	0.8
Ford	Explorer	UN	10/96	06/99	6	4.0L	VZA		R42LTS		41963*	1.3
Ford	Explorer	UP	10/96	06/99	6	4.0L	VZA		R42LTS		41963*	1.3
Ford	Explorer	US	06/99	10/01	6	4.0L	VZA		R42LTS		41963*	1.3
Ford	Explorer	UT	12/01	2003	6	4.0L	XZA	SOHC	R42LTS		41963*	1.3
Ford	Explorer	UT	12/01	2003	8	4.6L	2ZA	SOHC	R42LTS		41963*	1.3
Ford	Explorer	UX	03/03	12/03	6	4.0L	XZA	SOHC	R42LTS		41963*	1.3
Ford	Explorer	UX	03/03	12/03	8	4.6L	2ZA	SOHC	R42LTS		41963*	1.3
Ford	Explorer	UZ	12/03	2006	6	4.0L	XZA	SOHC	R42LTS		41963*	1.3
Ford	Explorer	UZ	12/03	2006	8	4.6L	2ZA	SOHC	R42LTS		41963*	1.3
Ford	F100		1967	1974	6	3.9L	240		R44TS			0.9
Ford	F100		1970	1981	6	4.1L	250		R44TS			0.9
Ford	F100		1974	1977	8	4.9L	302	Cleveland	R44TS			0.9
Ford	F100		1978	1985	8	5.8L	351	Cleveland	R44TS			0.9
Ford	F100		1981	1984	6	4.1L	250		R43XLS	AC4		0.8
Ford	F150		1996	2004	8	5.4L	330				41963*	1.4
Ford	F250		1967	1974	6	3.9L	240		R44TS			0.9
Ford	F250		1973	1985	8	5.8L	351	Cleveland	R44TS			0.9
Ford	F250		1978	1981	6	4.1L	250		R44TS			0.9
Ford	F250		1981	1984	6	4.1L	250		R43XLS	AC4		0.8
Ford	F250		2001	2004	8	5.4L	5.4				41963*	1.4
Ford	F350		1966	1974	6	3.9L	240		R44TS			0.9
Ford	F350		1970	1981	6	4.1L	250		R44TS			0.9
Ford	F350		1981	1984	6	4.1L	250		R43XLS	AC4		0.8
Ford	F350		1984	1985	8	5.8L	351	Cleveland	R44TS			0.9
Ford	F350		1988	1997	8	7.5L	460		R44TS			1.1
Ford	Fairlane	ZJ	1980	1982	6	4.0L		Alloy Head	43XLS	AC4		0.8
Ford	Fairlane	ZK	1982	1984	6	4.0L		Alloy Head	43XLS	AC4		0.8
Ford	Fairlane	ZL	1984	1988	6	4.1L			R9601	AC4	41802	1.1
Ford	Fairlane	NA	1988	1991	6	3.9L		SOHC	R9601	AC4	41802	1.1
Ford	Fairlane	NC	1991	1992	6	3.9L		SOHC	R9601	AC4	41802	1.1
Ford	Fairlane	NCII	1992	1993	6	4.0L		SOHC	R9601	AC4	41802	1.1
Ford	Fairlane	NF	1995	1996	6	4.0L		SOHC - Except Tickford Engine	R43XLS	AC4	41802	1.1
Ford	Fairlane	NF	1995	1996	6	4.0L		SOHC - Tickford Engine	R42XLS	AC4	41804	1.1
Ford	Fairlane	NL	1996	1999	6	4.0L		SOHC - Except Tickford Engine	R43XLS	AC4	41802	1.1
Ford	Fairlane	NL	1996	1999	6	4.0L		SOHC - Tickford Engine	R42XLS	AC4	41804	1.1
Ford	Fairlane	AU	1999	2000	6	4.0L		SOHC - Tickford Engine	R42XLS	AC4	41804	1.1
Ford	Fairlane	AU	03/99	06/00	8	5.0L	5.0		R44LTS6	AC14	41942	1.4

MAKE	MODEL	SERIES / BADGE	FROM	TO	CYLS	CAPACITY	ENGINE	ADDITIONAL INFORMATION	REGULAR	PLATINUM (RAPIDFIRE®)	DOUBLE PLATINUM	GAP (MM)#
Ford	Fairlane	AUII	2000	2003	6	4.0L		SOHC - incl. Tickford Engine			41802	1.3
Ford	Fairlane	AUII	07/00	12/02	8	5.0L	5.0		R44LTS6	AC14	41942	1.4
Ford	Fairlane	BA	07/03	09/05	6	4.0L	Barra 182	DOHC			41800	1.3
Ford	Fairmont	AU	09/98	04/00	8	5.0L	5.0		R44LTS6	AC14	41942	1.4
Ford	Fairmont	AUII	04/00	10/01	8	5.0L	5.0		R44LTS6	AC14	41942	1.4
Ford	Fairmont	AUIII	11/01	09/02	8	5.0L	5.0		R44LTS6	AC14	41942	1.4
Ford	Fairmont	XD	05/80	04/82	6			Alloy Head	43XLS	AC4		0.8
Ford	Fairmont	XE	03/82	10/84	6			Alloy Head	43XLS	AC4		0.8
Ford	Falcon	XD	1979	1982	6			Alloy Head	43XLS	AC4		0.8
Ford	Falcon	XE	1982	1984	6			Alloy Head	43XLS	AC4		0.8
Ford	Falcon	XF	1984	1988	6	4.1L			R9601	AC4	41802	1.1
Ford	Falcon	EA	03/88	10/91	6	3.9L			R9601	AC4	41802	1.1
Ford	Falcon	EB	07/91	04/92	6	3.9L			R9601	AC4	41802	1.1
Ford	Falcon	EBII GT	1992	1993	8	5.0L	5.0		R42LTS		41810	1.1
Ford	Falcon	EBII XR6	1992	1993	6	4.0L			R42XLS	AC4	41804	1.1
Ford	Falcon	ED XR6	1992	1994	6	4.0L			R42XLS	AC4	41804	1.1
Ford	Falcon	EBII	04/92	08/93	6	4.0L		Except XR6	R9601	AC4	41802	1.1
Ford	Falcon	ED	1993	1994	6	4.0L		Except XR6	R9601	AC4	41802	1.1
Ford	Falcon	ED GT	1993	1994	8	5.0L	5.0		R42LTS		41810	1.1
Ford	Falcon	EF	08/94	09/96	6	4.0L			R43XLS	AC4	41802	1.1
Ford	Falcon	EF XR6	08/94	1996	6	4.0L		Tickford	R42XLS	AC4	41804	1.1
Ford	Falcon	EL	09/96	08/98	6	4.0L			R43XLS	AC4	41802	1.1
Ford	Falcon	EL XR6	09/96	08/98	6	4.0L		VCT Tickford	R42XLS	AC4	41804	1.1
Ford	Falcon	AU	09/98	12/00	6	4.0L			R43XLS	AC4	41802	1.1
Ford	Falcon	AU XR6	09/98	12/00	6	4.0L		VCT Tickford	R42XLS	AC4	41804	1.1
Ford	Falcon	AU	09/98	04/00	8	5.0L	5.0		R44LTS6	AC14	41942	1.4
Ford	Falcon	AU XR8	07/99	04/00	8	5.0L	5.0		R44LTS6	AC14	41942	1.4
Ford	Falcon	AUII	04/00	2002	6	4.0L			R43XLS	AC4	41802	1.1
Ford	Falcon	AUII	04/00	02/02	6	4.0L	Factory LPG		R9601	AC4	41804	1.1
Ford	Falcon	AUII XR6	04/00	10/01	6	4.0L			R42XLS	AC4	41804	1.1
Ford	Falcon	AUII	04/00	02/02	8	5.0L	5.0		R44LTS6	AC14	41942	1.4
Ford	Falcon	AUII XR8	04/00	02/02	8	5.0L	5.0		R44LTS6	AC14	41942	1.4
Ford	Falcon	AUIII	11/01	09/02	6	4.0L		VCT Tickford			41802	1.3
Ford	Falcon	AUIII	11/01	09/02	6	4.0L	Factory LPG		R9601	AC4	41804	1.1
Ford	Falcon	AUIII XR6	11/01	09/02	6	4.0L		VCT Tickford			41802	1.3
Ford	Falcon	AUIII	11/01	09/02	8	5.0L	5.0		R44LTS6	AC14	41942	1.4
Ford	Falcon	AUIII XR8	04/00	02/02	8	5.0L	5.0		R44LTS6	AC14	41942	1.4
Ford	Falcon	TE50	12/01	12/02	8	5.6L	5.6		R42LTS		41963*	1.3
Ford	Falcon	TS50	12/01	12/02	8	5.6L	5.6		R42LTS		41963*	1.3
Ford	Falcon	Pursuit	02/02	09/02	8	5.6L	5.6		R42LTS		41963*	1.3
Ford	Falcon	BA	09/02	2005	6	4.0L	Barra 182	DOHC VCT			41800	1.3
Ford	Falcon	BA MK1	09/02	2004	6	4.0L	Factory LPG	DOHC VCT	41602	AC5	41966*	1.1
Ford	Falcon	BA XR6	09/02	2005	6	4.0L	Barra 240T	Turbo DOHC VCT	41629		41800	1.1

MAKE	MODEL	SERIES / BADGE	FROM	TO	CYLS	CAPACITY	ENGINE	ADDITIONAL INFORMATION	REGULAR	PLATINUM (RAPIDFIRE®)	DOUBLE PLATINUM	GAP (MM)#
Ford	Falcon	BA XR8	10/03	2005	8	5.4L	Boss 260				41963*	1.4
Ford	Falcon	BA MK11	09/04	2005	6	4.0L	Factory LPG	DOHC VCT	41602		41970*	0.8
Ford	Falcon	BF	10/05	07/11	6	4.0L	Barra 190	DOHC VCT	41602	AC5	41966*	1.1
Ford	Falcon	BF	10/05	07/11	6	4.0L	EGas	LPG DOHC VCT	41602		41970*	0.8
Ford	Falcon	BF XR6	10/05	04/08	6	4.0L	Barra 245T	Turbo DOHC VCT	41602	AC5	41970*	0.9
Ford	Falcon	BF XR8	10/05	04/08	8	5.4L	Boss 260		R42LTS		41810	1.0
Ford	Falcon	FG	02/08	11/14	6	4.0L	Barra 195	DOHC 24V VCT		AC5	41966*	1.3
Ford	Falcon	FG	02/08	on	6	4.0L	Factory LPG	DOHC VCT	41602		41970*	0.8
Ford	Falcon	FG G6ET	05/08	11/14	6	4.0L	Barra 270T	Turbo DOHC	41602	AC5	41966*	1.1
Ford	Falcon	FG XR6T	05/08	on	6	4.0L	Barra 270T	Turbo DOHC	41602	AC5	41801	1.1
Ford	Falcon	FG XR8	05/08	09/11	8	5.4L	Boss 290		R42LTS		41810	1.1
Ford	Falcon FPV	BA GT	03/03	09/05	8	5.4L	Boss 290		R42LTS		41810	1.1
Ford	Falcon FPV	BA GTP	03/03	09/05	8	5.4L	Boss 290		R42LTS		41810	1.1
Ford	Falcon FPV	BA F6 Typhoon	09/04	2005	6	4.0L	Barra 270T	Turbo DOHC VCT	41602	AC5	41801	1.1
Ford	Falcon FPV	BF F6 Tornado	10/05	05/08	6	4.0L	Barra 270T	Turbo DOHC VCT		AC5	41801	1.3
Ford	Falcon FPV	BF F6 Typhoon	10/05	05/08	6	4.0L	Barra 270T	Turbo DOHC VCT	41602	AC5	41970*	0.9
Ford	Falcon FPV	BF GT	10/05	01/08	8	5.4L	Boss 290		R42LTS		41810	1.1
Ford	Falcon FPV	BF GTP	10/05	01/08	8	5.4L	Boss 290		R42LTS		41810	1.1
Ford	Falcon FPV	BF Force 6	11/06	05/08	6	4.0L	Barra 270T	Turbo DOHC VCT	41602	AC5	41970*	0.9
Ford	Falcon FPV	BF Force 8	11/06	01/08	8	5.4L	Boss 290		R42LTS		41810	1.1
Ford	Falcon FPV	FG GT	06/08	09/10	8	5.4L	Boss 315		R42LTS		41810	1.1
Ford	Falcon FPV	FG GTP	06/08	09/10	8	5.4L	Boss 315		R42LTS		41810	1.1
Ford	Falcon FPV	FG Pursuit	06/08	09/10	8	5.4L	Boss 315		R42LTS		41810	1.1
Ford	Falcon FPV	FG Super Pursuit	06/08	09/10	8	5.4L	Boss 315		R42LTS		41810	1.1
Ford	Falcon FPV	FG GS	09/09	09/10	8	5.4L	Boss 302		R42LTS		41810	1.1
Ford	Falcon Ute	RTV	09/03	2005	6	4.0L	Barra 182	DOHC VCT			41800	1.3
Ford	Falcon Ute Longreach	XG	03/93	1996	6	4.0L		OHC	R43XLS	AC4	41802	1.1
Ford	Falcon Ute Longreach	XG XR6	03/93	1996	6	4.0L		VCT Tickford	R42XLS	AC4	41804	1.1
Ford	Falcon Ute Longreach	XH	04/96	1999	6	4.0L		OHC	R43XLS	AC4	41802	1.1
Ford	Falcon Ute Longreach	XH XR6	04/96	1999	6	4.0L		VCT Tickford	R42XLS	AC4	41804	1.1
Ford	Festiva	WA	1991	1994	4	1.3L	B3		R43XLS	AC4	41802	1.1
Ford	Festiva	WB	1994	1996	4	1.3L	B3		R43XLS	AC4	41802	1.1
Ford	Festiva	WD	1997	2001	4	1.3L	B3		R43XLS	AC4	41802	1.1
Ford	Festiva	WD	1997	1997	4	1.5L	B5		41602	AC5	41801	1.1
Ford	Festiva	WF	1997	2001	4	1.3L	B3		R43XLS	AC4	41802	1.1
Ford	Festiva	WF	01/98	2001	4	1.5L	B5		41602	AC5	41801	1.1
Ford	Fiesta	WP	04/04	05/07	4	1.6L	Duratec				41814	1.3

MAKE	MODEL	SERIES / BADGE	FROM	TO	CYLS	CAPACITY	ENGINE	ADDITIONAL INFORMATION	REGULAR	PLATINUM (RAPIDFIRE®)	DOUBLE PLATINUM	GAP (MM)#
Ford	Fiesta	WQ	06/07	12/08	4	1.6L	Duratec				41814	1.3
Ford	Fiesta	WQ - XR4	06/07	12/08	4	2.0L	N4J				41963*	1.3
Ford	Fiesta	WS	01/09	09/10	4	1.6L	Duratec				41814	1.3
Ford	Fiesta	WS	2009	2010	4	1.6L	Zetec				41814	1.3
Ford	Fiesta	WT	2009	on	4	1.6L	Zetec				41814	1.3
Ford	Fiesta	WT	10/10	07/13	4	1.6L	Duratec				41814	1.3
Ford	Focus	LR	2000	04/05	4	1.8L	EYDE				41814	1.3
Ford	Focus	LR	09/02	04/05	4	2.0L	Zetec				41814	1.3
Ford	Focus	LR ST170	05/03	2005	4	2.0L	Zetec				41814	1.3
Ford	Focus	LS	05/05	03/09	4	2.0L			R42LTS		41963*	1.3
Ford	Focus	LT	05/05	05/10	4	2.0L			R42LTS		41963*	1.3
Ford	Focus	LV	06/08	06/11	4	2.0L			R42LTS		41963*	1.3
Ford	Ka		11/99	12/03	4	1.3L	Endura E		R42LTS		41810	1.0
Ford	Laser	KA	03/81	09/85	4	1.3L	E3		R43XLS	AC4		0.8
Ford	Laser	KA	03/81	09/85	4	1.5L	E5		R43XLS	AC4		0.8
Ford	Laser	KB	03/81	09/85	4	1.3L	E3		R43XLS	AC4		0.8
Ford	Laser	KB	03/81	09/85	4	1.5L	E5		R43XLS	AC4		0.8
Ford	Laser		1985	1989	4	1.6L	B6		R43XLS	AC4	41802	1.1
Ford	Laser	KC	10/85	03/89	4	1.3L	E3		R43XLS	AC4		0.8
Ford	Laser	KC	10/85	04/90	4	1.6L	B6			AC4	41802	1.1
Ford	Laser	KE	10/85	03/89	4	1.3L	E3		R43XLS	AC4		0.8
Ford	Laser	KE	10/85	04/90	4	1.6L	B6			AC4	41802	1.1
Ford	Laser	KE	10/87	04/90	4	1.6L	B6T	Turbo	41602	AC5	41801	1.1
Ford	Laser	KF	03/90	12/91	4	1.6L	B6		FR3LS		41800	1.1
Ford	Laser	KF	03/90	10/94	4	1.8L	BP	DOHC	41602	AC5	41801	1.1
Ford	Laser	KF	03/90	10/94	4	1.8L	BPE	SOHC	FR3LS		41800	1.1
Ford	Laser	KF TX3	03/90	07/93	4	1.8L	BPT	Turbo	41602	AC5	41801	1.1
Ford	Laser	KH	03/90	10/94	4	1.8L	BPE	SOHC	FR3LS		41800	1.1
Ford	Laser	KH TX3	03/90	07/93	4	1.8L	BPT	Turbo	41602	AC5	41801	1.1
Ford	Laser	KH	08/90	10/94	4	1.8L	BP	DOHC	41602	AC5	41801	1.1
Ford	Laser	KH	10/91	10/94	4	1.6L	B6		FR3LS		41800	1.1
Ford	Laser	KJ	10/94	03/99	4	1.6L	B6		FR3LS		41800	1.1
Ford	Laser	KJ	10/94	12/98	4	1.8L	BP	DOHC	41602	AC5	41801	1.1
Ford	Laser	KN	03/99	08/02	4	1.6L	ZM				41806	1.1
Ford	Laser	KN	03/99	08/02	4	1.8L	FP		FR3LS		41800	1.1
Ford	Laser	KQ	03/99	08/02	4	1.6L	ZM				41806	1.1
Ford	Laser	KQ	03/99	08/02	4	1.8L	FP		FR3LS		41800	1.1
Ford	Laser	KQ	04/01	2002	4	2.0L	FS				41806	1.1
Ford	LTD	FC	1977	1982	8	5.8L	351	Cleveland	R44TS			0.9
Ford	LTD	FC	10/79	1982	6	4.1L	250	Alloy Head	R43XLS	AC4		0.8

MAKE	MODEL	SERIES / BADGE	FROM	TO	CYLS	CAPACITY	ENGINE	ADDITIONAL INFORMATION	REGULAR	PLATINUM (RAPIDFIRE®)	DOUBLE PLATINUM	GAP (MM)#
Ford	LTD	FD	1982	1984	6	4.1L	250	Alloy Head	R43XLS	AC4		0.8
Ford	LTD	FD	03/82	03/83	8	4.9L	302	Cleveland	R44TS			0.9
Ford	LTD	FD	03/82	03/83	8	5.8L	351	Cleveland	R44TS			0.9
Ford	LTD	FE	10/84	1988	6	4.1L	250		R9601	AC4	41802	1.1
Ford	LTD	DA	1988	1991	6	3.9L			R9601	AC4	41802	1.1
Ford	LTD	DC	1991	1992	6	3.9L			R9601	AC4	41802	1.1
Ford	LTD	DC	1992	1995	6	4.0L			R9601	AC4	41802	1.1
Ford	LTD	DF	03/95	09/96	6	4.0L		Except Tickford Engine	R43XLS	AC4	41802	1.1
Ford	LTD	DF	03/95	09/96	6	4.0L		Tickford Engine	R42XLS	AC4	41804	1.1
Ford	LTD	DL	09/96	06/99	6	4.0L		Except Tickford Engine	R43XLS	AC4	41802	1.1
Ford	LTD	DL	09/96	06/99	6	4.0L		Tickford Engine	R42XLS	AC4	41804	1.1
Ford	LTD	AU	06/99	2005	8	5.0L	5.0		R44LTS6	AC14	41942	1.4
Ford	LTD	AU	04/00	2003	6	4.0L		All Models incl Tickford			41802	1.3
Ford	Maverick	DA	02/88	1994	6	4.2L	TB42	CARB	R43XLS	AC4		0.8
Ford	Meteor	GA	1982	1983	4	1.5L	E5		43XLS	AC4		0.8
Ford	Meteor	GB	1983	1985	4	1.5L	E5		43XLS	AC4		0.8
Ford	Meteor	GC	10/85	1987	4	1.6L	B6		R43XLS	AC4	41802	1.1
Ford	Mondeo	HA	1995	1996	4	2.0L	ZH20				41814	1.3
Ford	Mondeo	HB	1996	1996	4	2.0L	ZH20				41814	1.3
Ford	Mondeo	HC	1996	1998	4	2.0L	ZH20				41814	1.3
Ford	Mondeo	HD	1998	2000	4	2.0L	ZH20				41814	1.3
Ford	Mondeo	HE	2000	2001	4	2.0L	ZH20				41814	1.3
Ford	Mondeo	HE ST25	02/00	2001	6	2.5L	KL		R42LTS		41963*	1.3
Ford	Mondeo	MA	10/07	06/09	4	2.3L	Duratec				41973*	1.0
Ford	Mondeo	MB	07/09	10/10	4	2.3L	Duratec				41973*	1.0
Ford	Mondeo	MC	11/10	on	4	2.3L	Duratec				41973*	1.0
Ford	Mustang		1993	1993	8	5.0L	302	F/I Vin D			41963*	1.4
Ford	Mustang		1999	1999	8	4.6L	281	F/I Vin V (Cobra)			41963*	1.4
Ford	Mustang		1999	1999	8	4.6L	281	F/I Vin X (GT)			41963*	1.4
Ford	Mustang Cobra		1994	1994	8	5.0L	302	F/I Vin D (Cobra)			41963*	1.4
Ford	Mustang Cobra		1995	1995	8	5.0L	302	F/I Vin D (Cobra SVT)			41963*	1.4
Ford	Mustang Cobra		1996	2001	8	4.6L	281	F/I Vin V (Cobra)			41963*	1.4
Ford	Mustang GT		1996	2000	8	4.6L	281	F/I Vin X (GT)			41963*	1.4
Ford	Mustang GT		2001	2001	8	4.6L	281	F/I Vin X			41963*	1.4
Ford	Mustang GT		2002	2004	8	4.6L	281	F/I Vin X (GT)			41963*	1.4
Ford	Mustang Mach 1		2003	2004	8	4.6L	281	F/I Vin R (Mach 1)			41963*	1.4
Ford	Panel Van	XF	1984	02/93	6	4.1L			R43XLS	AC4	41802	1.1
Ford	Probe	ST	1993	1997	6	2.5L	KL				41806	1.1
Ford	Probe	SU	1993	1998	6	2.5L	KL				41806	1.1
Ford	Probe	SV	1993	1999	6	2.5L	KL				41806	1.1
Ford	Raider	UF	08/91	1997	4	2.6L	G6	EFI			41806	1.1
Ford	Spectron		1983	1984	4	1.6L	NA		R43XLS	AC4		0.8
Ford	Spectron		1985	1987	4	1.8L	F8		R43XLS	AC4		0.8
Ford	Spectron		1986	1990	4	2.0L	FE		R43XLS	AC4		0.8

MAKE	MODEL	SERIES / BADGE	FROM	TO	CYLS	CAPACITY	ENGINE	ADDITIONAL INFORMATION	REGULAR	PLATINUM (RAPIDFIRE®)	DOUBLE PLATINUM	GAP (MM)#
Ford	Taurus	DN	1995	1998	6	3.0L	TA		R44LTS6		41942	1.3
Ford	Taurus	DP	1995	1998	6	3.0L	TA		R44LTS6		41942	1.3
Ford	Telstar	AS	03/83	11/87	4	2.0L	FE	Unleaded	R43XLS	AC4	41802	1.1
Ford	Telstar	AR	05/83	1985	4	2.0L	FE	Leaded	R43XLS	AC4		0.8
Ford	Telstar	AS	1986	1987	4	2.0L	FE	Turbo		AC4	41804	1.1
Ford	Telstar	AT	10/87	10/89	4	2.0L	FE	Unleaded	R43XLS	AC4	41802	1.1
Ford	Telstar	AT	10/87	12/91	4	2.2L	F2	Turbo			41806	1.1
Ford	Telstar	AV	10/87	12/91	4	2.2L	F2	Turbo			41806	1.1
Ford	Telstar	AX	01/92	11/96	4	2.0L	FS		FR3LS		41800	1.1
Ford	Telstar	AX	01/92	11/96	6	2.5L	KL				41806	1.1
Ford	Telstar	AY	01/92	11/96	4	2.0L	FS		FR3LS		41800	1.1
Ford	Telstar	AY	01/92	11/96	6	2.5L	KL				41806	1.1
Ford	Territory	SX	10/02	2005	6	4.0L	Barra 182				41800	1.3
Ford	Territory	SY	11/05	04/11	6	4.0L	Barra 190			AC5	41966*	1.3
Ford	Territory	SY	07/06	04/11	6	4.0L	Barra 245T	Turbo	41602	AC5	41970*	0.9
Ford	Territory	SZ	2011	10/16	6	4.0L	Barra 195		41602		41966*	1.1
Ford	Territory FPV	SY F6X	2008	2009	6	4.0L	Barra 270T	Turbo 270kW	41602	AC5	41801	1.1
Ford	Thunderbird		2002	2005	8	3.9L	242	F/I Vin A	41629		41800	1.1
Ford	Trader		06/79	1981	4	2.0L	VA		R42XLS	AC4	41804	0.8
Ford	Transit	VF	1996	1997	4	2.0L	NSJ		FR1LS			1.0
Ford	Transit	VG	1997	2001	4	2.0L	NSJ		FR1LS			1.0
Ford	Transit	VH	2000	2004	4	2.3L	E5FB		41602	AC5	41970*	0.9
Ford	Transit	VJ	2003	2006	4	2.3L	E5FB		41602	AC5	41970*	0.9
GMC												
GMC	C Series Pickup		1996	1999	8	5.0L		VIN M	R44LTS6		41976*	1.5
GMC	C Series Pickup		1996	1999	8	5.3L		VIN T	R44LTS6		41976*	1.5
GMC	C Series Pickup		1996	2000	8	5.7L		VIN R	R44LTS6		41976*	1.5
GMC	C Series Pickup		1996	2000	8	7.4L		VIN J	R44LTS6		41976*	1.5
GMC	K Series Pickup		1996	1999	8	5.0L		VIN M	R44LTS6		41976*	1.5
GMC	K Series Pickup		1996	1999	8	5.3L		VIN T	R44LTS6		41976*	1.5
GMC	K Series Pickup		1996	2000	8	5.7L		VIN R	R44LTS6		41976*	1.5
GMC	K Series Pickup		1996	2000	8	7.4L		VIN J	R44LTS6		41976*	1.5
GMC	Sierra		1996	1999	8	5.0L		VIN M/T	R44LTS6		41976*	1.5
GMC	Sierra		1996	1999	8	5.7L		VIN R	R44LTS6		41976*	1.5
GMC	Sierra		1996	1999	8	6.0L		VIN R	R44LTS6		41976*	1.5
GMC	Sierra		1996	1998	8	7.4L		VIN J	R44LTS6		41976*	1.5
GMC	Sierra		1999	2004	8	4.8L		VIN V			41971*	1.5
GMC	Sierra		2000	2004	8	5.3L		VIN T			41971*	1.5
GMC	Sierra		2000	2004	8	6.0L		VIN U			41971*	1.5
GMC	Suburban		1996	1999	8	5.0L		VIN M	R44LTS6		41976*	1.5
GMC	Suburban		1996	1999	8	5.3L		VIN T	R44LTS6		41976*	1.5
GMC	Suburban		1996	2000	8	5.7L		VIN R	R44LTS6		41976*	1.5
GMC	Suburban		1996	2000	8	7.4L		VIN J	R44LTS6		41976*	1.5
GMC	Yukon		1996	1999	8	5.7L		VIN R	R44LTS6		41976*	1.5
GMC	Yukon		2000	2007	8	5.3L		VIN T			41971*	1.5
GMC	Yukon		2000	2007	8	6.0L		VIN U			41971*	1.5

MAKE	MODEL	SERIES / BADGE	FROM	TO	CYLS	CAPACITY	ENGINE	ADDITIONAL INFORMATION	REGULAR	PLATINUM (RAPIDFIRE®)	DOUBLE PLATINUM	GAP (MM)#
GREAT WALL												
Great Wall	V240	K2 - Super Luxury	06/09	2014	4	2.4L	4G69S4N		41602		41966*	1.1
Great Wall	V240	K2	07/10	2014	4	2.4L	4G69S4N		41602		41966*	1.1
Great Wall	X240	CC	10/09	2014	4	2.4L	4G69S4N		41602		41966*	1.1
HOLDEN												
Holden	Adentra	VY	10/03	10/04	8	5.7L	LS1	GenIII			41805	1.5
Holden	Adentra	VZ	11/04	01/06	8	5.7L	LS1	GenIII			41805	1.5
Holden	Adentra	VZ	03/05	12/06	6	3.6L	LY7	HFV6 Alloytec			41972*	1.1
Holden	Apollo	JK	08/89	07/91	4	2.0L	3SFC		FR3LS		41800	1.1
Holden	Apollo	JK	08/89	02/93	4	2.0L	3SFE		FR3LS		41800	1.1
Holden	Apollo	JL	1991	1993	4	2.0L	3SFE		FR3LS		41800	1.1
Holden	Apollo	JM	03/93	05/97	4	2.2L	5SFE		41629		41800	1.1
Holden	Apollo	JM	03/93	05/97	6	3.0L	3VZFE		41602	AC5	41801	1.1
Holden	Apollo	JP	03/93	05/97	4	2.2L	5SFE		41629		41800	1.1
Holden	Apollo	JP	03/93	05/97	6	3.0L	3VZFE		41602	AC5	41801	1.1
Holden	Astra	LB	1984	1985	4	1.5L	E15		43XLS	AC4		0.8
Holden	Astra	LC	03/86	1987	4	1.6L	E16		R43XLS	AC4	41802	1.1
Holden	Astra	LD	07/87	07/89	4	1.6L	16LF		R42XLS	AC4	41804	1.1
Holden	Astra	LD	07/87	07/89	4	1.8L	18LE		R42XLS	AC4	41804	1.1
Holden	Astra	TR	09/96	09/98	4	1.6L	C16SE		41629		41969*	0.8
Holden	Astra	TR	09/96	1998	4	1.8L	C18SEL	16V	41602		41970*	0.8
Holden	Astra	TR	09/96	1998	4	2.0L	X20XEV	16V	R5602		41969*	0.8
Holden	Astra	TS	1998	2001	4	1.8L	X18XE1		41629		41969*	0.8
Holden	Astra	TS	08/98	12/05	4	1.8L	Z18XE		41629		41969*	0.8
Holden	Astra	TS	05/03	07/04	4	2.0L	Z20LET	Turbo	41629		41969*	0.8
Holden	HSV Astra VXR	AH	09/06	09/09	4	2.0L	Z20LEH		41602	AC5	41801	1.0
Holden	Astra	AH	11/04	03/07	4	1.8L	Z18XE		41629		41969*	0.8
Holden	Astra	AH	2007	2009	4	2.0L	Z20LER	Turbo			41967*	1.0
Holden	Astra	AH	2007	2009	4	2.2L	Z22YH				41970*	0.7
Holden	Astra	AH	04/07	03/10	4	1.8L	Z18XER		41629		41969*	0.8
Holden	Astra	PJ	05/15	on	4	2.0L	B20NFT	Turbo			41973*	0.9
Holden	Barina	MB	02/85	01/89	4	1.3L	G13A		43XLS	AC4		0.8
Holden	Barina	ML	02/85	01/89	4	1.3L	G13A		43XLS	AC4		0.8
Holden	Barina	MF	02/89	05/94	4	1.3L	G13B		R42XLS	AC4	41804	0.8
Holden	Barina	MH	02/89	05/94	4	1.3L	G13B		R42XLS	AC4	41804	0.8
Holden	Barina	SB	04/94	07/97	4	1.2L	C12NZ	To Eng No. 19341712 and Eng No. 02BD0921	41602		41970*	0.8
Holden	Barina	SB	04/94	2001	4	1.2L	C12NZ	From Eng No. 19341713 and Eng. No. 02BD0922	R5602		41969*	0.8
Holden	Barina	SB	04/94	2001	4	1.4L	C14NZ	To Eng No. 19241622 and Eng No. 02BF1475	41602		41970*	0.8

MAKE	MODEL	SERIES / BADGE	FROM	TO	CYLS	CAPACITY	ENGINE	ADDITIONAL INFORMATION	REGULAR	PLATINUM (RAPIDFIRE®)	DOUBLE PLATINUM	GAP (MM)#
Holden	Barina	SB	04/94	2001	4	1.4L	C14NZ	From Eng No. 19241623 and Eng No. 02BF1476	R5602		41969*	0.8
Holden	Barina	SB	04/94	1995	4	1.6L	C16XE				41970*	0.7
Holden	Barina	SB	04/94	1998	4	1.6L	X16XE		41629		41969*	0.7
Holden	Barina	SB Cabrio	11/97	11/00	4	1.4L	C14SE		41629		41969*	0.8
Holden	Barina	XC	02/01	12/05	4	1.4L	Z14XE		41629		41969*	0.8
Holden	Barina	XC	02/01	12/05	4	1.4L	Z14XEP				41982*	0.8
Holden	Barina	XC	09/01	13/05	4	1.8L	Z18XE		41629		41969*	0.8
Holden	Barina	TK	10/05	10/11	4	1.6L	F16D				41970*	0.7
Holden	Barina	TM	11/11	on	4	1.6L	A16XER (LDE)		41602		41982*	0.9
Holden	Calibra	YE	10/91	07/95	4	2.0L	C20NE	SOHC	R43XLS	AC4		0.8
Holden	Calibra	YE	10/91	1998	4	2.0L	C20XE	DOHC	41602		41970*	0.8
Holden	Calibra	YE	10/91	1995	4	2.0L	X20XEV	SOHC	R5602		41969*	0.8
Holden	Calibra	YE	06/94	1998	4	2.0L	C20LET	Turbo DOHC	R5610		41806	1.1
Holden	Calibra	YE95	08/95	1998	6	2.5L	C25XE		41602		41970*	0.8
Holden	Camira	JB	08/82	12/84	4	1.6L	16JH		R42XLS	AC4	41804	0.8
Holden	Camira	JD	11/84	02/86	4	1.6L	16JH		R42XLS	AC4	41804	0.8
Holden	Camira	JD	11/84	05/87	4	1.8L	18JU		R42XLS	AC4	41804	0.8
Holden	Camira	JE	04/87	1989	4	2.0L	20JD		R42XLS	AC4	41804	1.1
Holden	Caprice	VQ	03/90	1999	8	5.0L	LB9		R42LTS		41810	1.0
Holden	Caprice	VR	1994	1995	8	5.0L	LB9		R42LTS		41810	1.0
Holden	Caprice	VS	1995	1999	6	3.8L	LG2	Ecotec	R42LTS6		41976*	1.5
Holden	Caprice	VS	1995	1999	8	5.0L	LB9		R42LTS		41810	1.0
Holden	Caprice	VS	10/96	16/99	6	3.8L	L67	Ecotec Supercharged			41976*	1.3
Holden	Caprice	WH	06/99	08/01	6	3.8L	L67	Ecotec Supercharged			41942	1.3
Holden	Caprice	WH	06/99	04/03	6	3.8L	LN3	Ecotec	R42LTS6		41976*	1.5
Holden	Caprice	WH	06/99	04/03	8	5.7L	LS1	GenIII			41971*	1.5
Holden	Caprice	WK	05/03	07/04	6	3.8L	LN3	Ecotec	R42LTS6		41976*	1.5
Holden	Caprice	WK	05/03	07/04	8	5.7L	LS1	GenIII			41971*	1.5
Holden	Caprice	WL	08/04	07/06	6	3.6L	LY7	HFV6 Alloytec			41972*	1.1
Holden	Caprice	WL	08/04	01/06	8	5.7L	LS1	GenIII			41971*	1.5
Holden	Caprice	WL	02/06	07/06	8	6.0L	L76	GenIV			41977*	1.0
Holden	Caprice	WM	08/06	08/09	6	3.6L	LY7	HFV6 Alloytec			41972*	1.1
Holden	Caprice	WM	08/06	10/08	8	6.0L	L98	GenIV			41977*	1.0
Holden	Caprice	WM	11/08	08/10	8	6.0L	L76	GenIV			41977*	1.0
Holden	Caprice	WM	2009	2011	6	3.6L	LWR	HFV6 Alloytec LPG			41973*	1.1
Holden	Caprice	WM	09/09	08/11	6	3.6L	LLT	HFV6 Alloytec SIDI			41972*	1.1
Holden	Caprice	WM	11/11	05/13	6	3.6L	LFX	HFV6 Alloytec SIDI E85			41973*	1.1
Holden	Caprice	WN	05/13	on	6	3.6L	LWR	HFV6 Alloytec LPG			41973*	1.1
Holden	Caprice V	WM	09/10	05/13	8	6.0L	L77	GenIV E85			41977*	1.0

MAKE	MODEL	SERIES / BADGE	FROM	TO	CYLS	CAPACITY	ENGINE	ADDITIONAL INFORMATION	REGULAR	PLATINUM (RAPIDFIRE®)	DOUBLE PLATINUM	GAP (MM)#
Holden	Caprice V	WN	05/13	on	8	6.0L	L77	GenIV E85			41977*	1.0
Holden	Captiva	CG	2006	2010	6	3.2L	LU1	HFV6 Alloytec			41972*	1.1
Holden	Captiva	CG	2009	2011	4	2.4L	LD9				41967*	1.0
Holden	Captiva 5	CG Series II	01/11	05/12	4	2.4L	IE5				41973*	1.0
Holden	Captiva 5	CG Series II	06/12	on	4	2.4L	IE9				41973*	1.0
Holden	Captiva 7	CG Series II	2011	2011	6	3.0L	LF1	HFV6 Alloytec SIDI			41973*	1.1
Holden	Captiva 7	CG Series II	01/11	05/12	4	2.4L	IE5				41973*	1.0
Holden	Captiva 7	CG Series II	2012	on	6	3.0L	LFW	HFV6 Alloytec SIDI			41973*	1.1
Holden	Captiva 7	CG Series II	06/12	on	4	2.4L	IE9				41973*	1.0
Holden	Colorado	RC	2008	2011	6	3.6L	LCA	HFV6 Alloytec			41972*	1.1
Holden	Colorado	RC	08/08	11/09	4	2.4L	Y24SE	92kW SOHC	R42XLS	AC4	41804	1.1
Holden	Combo	SB	03/96	2002	4	1.4L	C14NZ		41629		41969*	0.8
Holden	Combo	SB	11/97	1999	4	1.4L	C14SE		41629		41969*	0.8
Holden	Combo	XC	02/01	on	4	1.4L	Z14XEP				41982*	0.8
Holden	Combo	XC	09/02	04/05	4	1.6L	Z16SE		41629		41969*	0.8
Holden	Commodore	VB	11/78	02/80	6	2.85L	LD1		R44TS			0.9
Holden	Commodore	VB	11/78	02/80	6	3.3L	L14		R44TS			0.9
Holden	Commodore	VB	11/78	02/80	8	4.2L	L36		R44TS			0.9
Holden	Commodore	VB	11/78	02/80	8	5.0L	L31		R44TS			0.9
Holden	Commodore	VC	1980	1981	6	2.8L	LD1		R42LTS6		41976*	1.5
Holden	Commodore	VC	1980	1981	6	3.3L	L14		R42LTS6		41976*	1.5
Holden	Commodore	VC	04/80	1981	4	1.9L	L18		R42LTS		41810	0.9
Holden	Commodore	VH	1981	1983	4	1.9L	L18		R42LTS		41810	0.9
Holden	Commodore	VH	1981	1984	6	2.8L	LD1		R42LTS6		41976*	1.5
Holden	Commodore	VH	1981	1984	6	3.3L	L14		R42LTS6		41976*	1.5
Holden	Commodore	VK	1984	1986	6	3.3L	L14		R42LTS6		41976*	1.5
Holden	Commodore	VL	03/86	08/88	6	3.0L	RB30				41825	1.1
Holden	Commodore	VL	08/86	08/88	6	3.0L	RB30T	Turbo			41825	1.1
Holden	Commodore	VL	10/86	08/88	8	5.0L	LB9	Walkinshaw	R42LTS		41810	1.0
Holden	Commodore	VG	08/88	1991	6	3.8L	LG2	Ecotec	R42LTS6		41976*	1.5
Holden	Commodore	VN	08/88	1991	6	3.8L	LG2	Ecotec	R42LTS6		41976*	1.5
Holden	Commodore	VN	03/89	09/91	8	5.0L	LB9		R42LTS		41810	1.0
Holden	Commodore	VP	10/91	1993	6	3.8L	LG2	Ecotec	R42LTS6		41976*	1.5
Holden	Commodore	VP	10/91	07/93	8	5.0L	LB9		R42LTS		41810	1.0
Holden	Commodore	VR	1993	1995	6	3.8L	LG2	Ecotec	R42LTS6		41976*	1.5
Holden	Commodore	VR	07/93	04/95	8	5.0L	LB9		R42LTS		41810	1.0
Holden	Commodore	VS	1995	1997	6	3.8L	LG2	Ecotec	R42LTS6		41976*	1.5
Holden	Commodore	VS	04/95	08/97	8	5.0L	LB9		R42LTS		41810	1.0
Holden	Commodore	VS Series II	08/95	1997	6	3.8L	L67	Ecotec Supercharged			41976*	1.3
Holden	Commodore	VT	1997	2000	6	3.8L	LN3	Ecotec	R42LTS6		41976*	1.5
Holden	Commodore	VT	08/97	2000	6	3.8L	L67	Ecotec Supercharged			41976*	1.3

MAKE	MODEL	SERIES / BADGE	FROM	TO	CYLS	CAPACITY	ENGINE	ADDITIONAL INFORMATION	REGULAR	PLATINUM (RAPIDFIRE®)	DOUBLE PLATINUM	GAP (MM)#
Holden	Commodore	VT	09/97	06/99	8	5.0L	LB9		R42LTS		41810	1.0
Holden	Commodore	VT Series II	06/99	09/00	8	5.7L	LS1	GenIII			41971*	1.5
Holden	Commodore	VX	10/00	2002	6	3.8L	L67	Ecotec Supercharged			41976*	1.3
Holden	Commodore	VX	10/00	2002	6	3.8L	LN3	Ecotec	R42LTS6		41976*	1.5
Holden	Commodore	VX	08/01	10/02	8	5.7L	LS1	GenIII			41971*	1.5
Holden	Commodore	VY	09/02	2004	6	3.8L	LN3	Ecotec	R42LTS6		41976*	1.5
Holden	Commodore	VY	09/02	07/05	8	5.7L	LS1	GenIII			41971*	1.5
Holden	Commodore	VY	10/02	07/04	6	3.8L	L67	Ecotec Supercharged	R44LTS6		41942	1.3
Holden	Commodore	VZ	08/04	08/07	6	3.6L	LE0	HFV6 Alloytec			41972*	1.1
Holden	Commodore	VZ	08/04	08/07	6	3.6L	LY7	HFV6 Alloytec			41972*	1.1
Holden	Commodore	VZ	08/04	01/06	8	5.7L	LS1	GenIII			41971*	1.5
Holden	Commodore	VZ	2006	2007	8	6.0L	L76	GenIV			41977*	1.0
Holden	Commodore	VE	2006	2010	8	6.0L	L98	GenIV			41977*	1.0
Holden	Commodore	VE	08/06	2009	6	3.6L	LE0	HFV6 Alloytec			41972*	1.1
Holden	Commodore	VE	08/06	2009	6	3.6L	LY7	HFV6 Alloytec			41972*	1.1
Holden	Commodore	VE	2009	2010	6	3.0L	LF1	HFV6 Alloytec SIDI			41973*	1.1
Holden	Commodore	VE	2009	2011	6	3.6L	LLT	HFV6 Alloytec SIDI			41972*	1.1
Holden	Commodore	VE	2009	2010	8	6.0L	L76	GenIV			41977*	1.0
Holden	Commodore	VE Series II	2010	05/13	6	3.0L	LFW	HFV6 Alloytec SIDI E85			41973*	1.1
Holden	Commodore	VE Series II	2010	05/13	8	6.0L	L77	GenIV E85			41977*	1.0
Holden	Commodore	VE Series II	2011	05/13	6	3.6L	LFX	HFV6 Alloytec SIDI E85			41973*	1.1
Holden	Commodore	VE Series II	2011	05/13	6	3.6L	LWR	HFV6 Alloytec LPG			41973*	1.1
Holden	Commodore	VF	05/13	10/15	6	3.0L	LFW	HFV6 Alloytec SIDI E85			41973*	1.1
Holden	Commodore	VF	05/13	10/15	6	3.6L	LFX	HFV6 Alloytec SIDI E85			41973*	1.1
Holden	Commodore	VF	05/13	10/15	6	3.6L	LWR	HFV6 Alloytec LPG			41973*	1.1
Holden	Commodore	VF	05/13	10/15	8	6.0L	L77	GenIV E85			41977*	1.0
Holden	Commodore	VF Series II	10/15	on	6	3.0L	LFW	HFV6 Alloytec SIDI E85			41973*	1.1
Holden	Commodore	VF Series II	10/15	on	6	3.6L	LFX	HFV6 Alloytec SIDI E85			41973*	1.1
Holden	Commodore	VF Series II	10/15	on	8	6.2L	LS3	GenIV E85			41977*	1.0
Holden	Commodore Ute	VG	1990	1991	8	5.0L	LB9		R42LTS		41810	1.0
Holden	Commodore Ute	VP	1991	1993	8	5.0L	LB9		R42LTS		41810	1.0
Holden	Commodore Ute	VP	10/91	1993	6	3.8L	LG2	Ecotec	R42LTS6		41976*	1.5
Holden	Commodore Ute	VR	1993	1995	6	3.8L	LG2	Ecotec	R42LTS6		41976*	1.5
Holden	Commodore Ute	VR	1993	1995	8	5.0L	LB9		R42LTS		41810	1.0
Holden	Commodore Ute	VS	1995	2000	6	3.8L	LG2	Ecotec	R42LTS6		41976*	1.5
Holden	Commodore Ute	VS	1995	2000	8	5.0L	LB9		R42LTS		41810	1.0
Holden	Commodore Ute	VS Series III	04/95	12/00	6	3.8L	LG2	Ecotec	R42LTS6		41976*	1.5
Holden	Commodore Ute	VS Series III	1999	2000	8	5.7L	LS1	GenIII			41971*	1.5
Holden	Commodore Ute	VU	12/00	09/02	6	3.8L	LN3	Ecotec	R42LTS6		41976*	1.5
Holden	Commodore Ute	VU	2002	2002	8	5.7L	LS1	GenIII			41971*	1.5

MAKE	MODEL	SERIES / BADGE	FROM	TO	CYLS	CAPACITY	ENGINE	ADDITIONAL INFORMATION	REGULAR	PLATINUM (RAPIDFIRE®)	DOUBLE PLATINUM	GAP (MM)#
Holden	Commodore Ute	VY Series I	2002	07/04	8	5.7L	LS1	GenIII			41971*	1.5
Holden	Commodore Ute	VY Series II	08/03	02/06	8	5.7L	LS1	GenIII			41971*	1.5
Holden	Commodore Ute	VZ	08/04	08/07	6	3.6L	LE0	HFV6 Alloytec			41972*	1.1
Holden	Crewman	VY	09/03	07/04	6	3.8L	LN3	Ecotec	R42LS6		41976*	1.5
Holden	Crewman	VY Cross 8	10/03	10/04	8	5.7L	LS1	GenIII			41805	1.5
Holden	Crewman	VZ Cross 8	11/04	01/06	8	5.7L	LS1	GenIII			41805	1.5
Holden	Crewman	VZ Cross 6	02/05	07/06	6	3.6L	LE0	HFV6 Alloytec			41972*	1.1
Holden	Cruze	YG	2002	2006	4	1.5L	M15A		41629		41800	1.1
Holden	Cruze	JG	06/09	02/11	4	1.8L	Z18XER (2HO)				41982*	0.8
Holden	Cruze	JH	03/11	03/13	4	1.8L	F18D4 (2HO)				41982*	0.8
Holden	Cruze	JH	03/13	on	4	1.8L	Z18XFR (LUVV)				41982*	0.7
Holden	Cruze	JH	03/13	on	4	1.6L	A16LET (LLU)				41982*	0.9
Holden	Drover	1300	1985	1987	4	1.3L			43XLS	AC4		0.8
Holden	Epica	EP	2007	2009	6	2.0L	X20D				41966*	1.1
Holden	Epica	EP	2007	2011	6	2.5L	X25D				41966*	1.1
Holden	Frontera	MB UED55	10/95	1999	4	2.0L	X20SE		41602		41970*	0.8
Holden	Frontera	MX UES30	02/99	2000	4	2.2L	X22SE		41629		41800	1.1
Holden	Frontera	MX UES25	03/99	2000	6	3.2L	6VD1		41629		41800	1.1
Holden	Gemini	TX	03/75	1977	4	1.6L	G161Z		R42XLS	AC4	41804	0.8
Holden	Gemini	TC	1977	1978	4	1.6L	G161Z		R42XLS	AC4	41804	0.8
Holden	Gemini	TE	1977	1981	4	1.6L	G161Z		R42XLS	AC4	41804	0.8
Holden	Gemini	TF	1977	1984	4	1.6L	G161Z		R42XLS	AC4	41804	0.8
Holden	Gemini	TG	1977	1985	4	1.6L	G161Z		R42XLS	AC4	41804	0.8
Holden	Gemini	TD	1978	1979	4	1.6L	G161Z		R42XLS	AC4	41804	0.8
Holden	Gemini	RB	05/85	1987	4	1.5L	4XC1		R43XLS	AC4	41802	1.1
Holden	Holden	FB	1960	1961	6	2.3L	138				41833	0.8
Holden	Holden	EK	1961	1962	6	2.3L	138				41833	0.8
Holden	Holden	EJ	1962	1963	6	2.3L	138				41833	0.8
Holden	Holden	EH	1963	1965	6	2.5L	149		43XLS	AC4		0.8
Holden	Holden	EH	1963	1965	6	3.0L	179		43XLS	AC4		0.8
Holden	Holden	HR	1966	1968	6	2.6L	161		43XLS	AC4		0.8
Holden	Holden	HR	1966	1968	6	3.1L	186		43XLS	AC4		0.8
Holden	Holden	HK	1968	1969	6	2.6L	161		43XLS	AC4		0.8
Holden	Holden	HK	1968	1969	6	3.1L	186		43XLS	AC4		0.8
Holden	Holden	HK	1968	1969	8	4.9L	307				41833	0.8
Holden	Holden	HK	1968	1969	8	5.4L	327				41833	0.8
Holden	Holden	HT	1969	1970	6	2.6L	161		43XLS	AC4		0.8
Holden	Holden	HT	1969	1970	6	3.1L	186		43XLS	AC4		0.8
Holden	Holden	HT	1969	1970	8	4.2L	253		R44TS			0.9
Holden	Holden	HT	1969	1970	8	4.9L	307				41833	0.8
Holden	Holden	HT	1969	1970	8	5.0L	308		R44TS			0.9
Holden	Holden	HT	1969	1970	8	5.7L	350				41833	0.8
Holden	Holden	HG	1970	1971	6	2.6L	161		43XLS	AC4		0.8
Holden	Holden	HG	1970	1971	6	3.1L	186		43XLS	AC4		0.8

MAKE	MODEL	SERIES / BADGE	FROM	TO	CYLS	CAPACITY	ENGINE	ADDITIONAL INFORMATION	REGULAR	PLATINUM (RAPIDFIRE®)	DOUBLE PLATINUM	GAP (MM)#
Holden	Holden	HG	1970	1971	8	4.2L	253		R44TS			0.9
Holden	Holden	HG	1970	1971	8	5.0L	308		R44TS			0.9
Holden	Holden	HG	1970	1971	8	5.7L	350				41833	0.8
Holden	Holden	HQ	1971	1974	8	4.2L	253		R44TS			0.9
Holden	Holden	HQ	1971	1974	8	5.0L	308		R44TS			0.9
Holden	Holden	HJ	1974	1976	8	4.2L	253		R44TS			0.9
Holden	Holden	HJ	1974	1976	8	5.0L	308		R44TS			0.9
Holden	Holden	HX	1976	1977	6	3.3L	202		R44TS			0.9
Holden	Holden	HX	1976	1977	8	4.2L	253		R44TS			0.9
Holden	Holden	HX	1976	1977	8	5.0L	308		R44TS			0.9
Holden	Holden	HZ	1977	1980	6	3.3L	202		R44TS			0.9
Holden	Holden	HZ	1977	1980	8	4.2L	253		R44TS			0.9
Holden	Holden	HZ	1977	1980	8	5.0L	308		R44TS			0.9
Holden	Jackaroo	UBS	11/81	1987	4	2.0L	G200		R42XLS	AC4	41804	0.8
Holden	Jackaroo	UBS	08/85	06/88	4	2.3L	4ZD1		R42XLS	AC4	41804	0.8
Holden	Jackaroo	UBS	1992	02/98	6	3.2L	6VD1		41602	AC5	41801	1.1
Holden	Jackaroo	UBS	02/98	2005	6	3.5L	6VE1		FR3LS		41800	1.1
Holden	Jackaroo	UBS	07/98	03/92	4	2.6L	4ZE1		R42XLS	AC4	41804	1.1
Holden	Malibu	EM	06/13	on	4	2.4L	LE9				41973*	1.0
Holden	Monaro	V2 CV6	10/01	2003	6	3.8L	l67	Ecotec Supercharged	R44LTS6		41942	1.3
Holden	Monaro	V2 CV8	10/01	2004	8	5.7L	LS1	GenIII			41971*	1.5
Holden	Monaro	VZ CV8	09/04	2006	8	5.7L	LS1	GenIII			41971*	1.5
Holden	Nova	LE	1989	1993	4	1.4L	6AFC				41806	1.1
Holden	Nova	LE	1989	1994	4	1.6L	4AFC				41806	1.1
Holden	Nova	LF	1991	1994	4	1.6L	4AFE		FR3LS		41969*	0.8
Holden	Nova	LF	1992	1994	4	1.8L	7AFE		FR3LS		41969*	0.8
Holden	Nova	LG	1994	1995	4	1.6L	4AFE		FR3LS		41969*	0.8
Holden	Nova	LG	1994	1996	4	1.8L	7AFE		FR3LS		41969*	0.8
Holden	One Tonner	WB	04/80	12/85	6	3.3L	202 Blue		R44LTS6		41976*	1.5
Holden	One Tonner	VY	05/03	07/04	6	3.8L	LN3	Ecotec	R42LTS6		41976*	1.5
Holden	One Tonner	VY	05/03	07/04	8	5.7L	LS1	GenIII			41805	1.5
Holden	Piazza	YB	04/86	1988	4	2.0L	4ZC1T	Turbo	R42XLS	AC4	41804	1.1
Holden	Rodeo	KB	1978	1985	4	1.6L	G161		R42XLS	AC4	41804	0.8
Holden	Rodeo	KB	1981	1987	4	2.0L	G200		R42XLS	AC4	41804	0.8
Holden	Rodeo	KB	1982	1984	4	1.8L	G180Z		R42XLS	AC4	41804	0.8
Holden	Rodeo	KB	1985	1988	4	2.3L	4ZD1		R42XLS	AC4	41804	0.8
Holden	Rodeo	TF	07/88	1998	4	2.6L	4ZE1		R42XLS	AC4	41804	1.0
Holden	Rodeo	TF	06/98	2003	4	2.2L	C22NE		R42XLS	AC4	41804	1.1
Holden	Rodeo	TF	02/99	2003	6	3.2L	6VD1		FR3LS		41800	1.1
Holden	Rodeo	RA	02/03	11/05	6	3.5L	6VE1		41629		41800	1.1
Holden	Rodeo	RA	03/03	11/05	4	2.4L	C24SE		R42XLS	AC4	41804	1.1
Holden	Rodeo	RA	09/05	09/08	6	3.6L	LCA	HFV6 Alloytec			41972*	1.1
Holden	Rodeo	RA	12/05	06/08	4	2.4L	Y24SE		R42XLS	AC4	41804	1.1
Holden	Scurry	NB	07/85	1987	4	1.0L	F10A		R43XLS	AC4		0.8
Holden	Shuttle	WFR	03/82	03/87	4	1.8L	4ZB1		R42XLS	AC4	41804	0.8
Holden	Shuttle	WFR	09/83	1991	4	2.0L	4ZC1		R42XLS	AC4	41804	0.8

MAKE	MODEL	SERIES / BADGE	FROM	TO	CYLS	CAPACITY	ENGINE	ADDITIONAL INFORMATION	REGULAR	PLATINUM (RAPIDFIRE®)	DOUBLE PLATINUM	GAP (MM)#
Holden	Statesman	VQ	1990	1994	6	3.8L	LG2	Ecotec	R42LTS6		41976*	1.5
Holden	Statesman	VQ	03/90	1999	8	5.0L	LB9		R42LTS		41810	1.0
Holden	Statesman	VR	1994	1995	6	3.8L	LG2	Ecotec	R42LTS6		41976*	1.5
Holden	Statesman	VR	1994	1995	8	5.0L	LB9		R42LTS		41810	1.0
Holden	Statesman	VR	05/94	1995	8	5.7L	304 Stroker		R42LTS		41810	1.0
Holden	Statesman	VS	1995	1999	6	3.8L	LG2	Ecotec	R42LTS6		41976*	1.5
Holden	Statesman	VS	1995	1999	8	5.0L	LB9		R42LTS		41810	1.0
Holden	Statesman	VS	1995	1996	8	5.7L	304 Stroker		R42LTS		41810	1.0
Holden	Statesman	VS	10/96	06/99	6	3.8L	L67	Ecotec Supercharged			41976*	1.3
Holden	Statesman	WH	06/99	04/03	6	3.8L	L67	Ecotec Supercharged			41942	1.3
Holden	Statesman	WH	06/99	04/03	6	3.8L	LN3	Ecotec	R42LTS6		41976*	1.5
Holden	Statesman	WH	06/99	04/03	8	5.7L	LS1	GenIII			41971*	1.5
Holden	Statesman	WK	05/03	2004	6	3.8L	L67	Ecotec Supercharged	R44LTS6		41942	1.3
Holden	Statesman	WK	05/03	07/04	6	3.8L	LN3	Ecotec	R42LTS6		41976*	1.5
Holden	Statesman	WK	05/03	07/04	8	5.7L	LS1	GenIII			41971*	1.5
Holden	Statesman	WL	08/04	07/06	6	3.6L	LY7	HFV6 Alloytec			41972*	1.1
Holden	Statesman	WL	08/04	07/06	8	5.7L	LS1	GenIII			41971*	1.5
Holden	Statesman	WL	02/06	07/06	8	6.0L	L76	GenIV			41977*	1.0
Holden	Statesman	WM	08/06	08/09	6	3.6L	LY7	HFV6 Alloytec			41972*	1.1
Holden	Statesman	WM	08/06	10/08	8	6.0L	L98	GenIV			41977*	1.0
Holden	Statesman	WM	11/08	08/10	8	6.0L	L76	GenIV			41977*	1.0
Holden	Statesman	WM	2009	2010	6	3.6L	LLT	HFV6 Alloytec SIDI			41972*	1.1
Holden	Statesman Caprice	HJ	1974	1976	8	5.0L	308		R44TS			0.9
Holden	Statesman Caprice	HX	1976	1977	8	5.0L	308		R44TS			0.9
Holden	Statesman Caprice	HZ	1977	1980	8	5.0L	308		R44TS			0.9
Holden	Statesman De Ville	HJ	1974	1976	8	5.0L	308		R44TS			0.9
Holden	Statesman De Ville	HX	1976	1977	8	5.0L	308		R44TS			0.9
Holden	Statesman De Ville	HZ	1977	1980	8	5.0L	308		R44TS			0.9
Holden	Suburban	FK1-1500	02/98	2000	8	5.7L			R44LTS6		41976*	1.5
Holden	Sunbird	UC	09/78	1980	4	1.9L	Starfire		R42LTS		41810	0.9
Holden	Tigra	XC	09/05	09/07	4	1.8L	Z18XE				41982*	0.8
Holden	Torana	HB	03/67	1969	4	1.2L			42XLS			0.8
Holden	Torana	LC	1969	1972	6			With Gasket Seats	43XLS	AC4		0.8
Holden	Torana	LC	11/69	02/72	4	1.2L			42XLS			0.8
Holden	Torana	LC XU-1	1970	1972	6	3.0L	186		R42XLS	AC4	41804	0.8

MAKE	MODEL	SERIES / BADGE	FROM	TO	CYLS	CAPACITY	ENGINE	ADDITIONAL INFORMATION	REGULAR	PLATINUM (RAPIDFIRE®)	DOUBLE PLATINUM	GAP (MM)#
Holden	Torana	IJ XU-1	1972	1974	6	3.3L	202		R42XLS	AC4	41804	0.8
Holden	Torana	IJ	02/72	1973	4	1.2L			42XLS			0.8
Holden	Torana	IJ	02/72	03/74	4	1.3L			42XLS			0.8
Holden	Torana	TA	03/74	03/75	4	1.3L			42XLS			0.8
Holden	Trax	TJ	2013	on	4	1.8L	F18D4 (2HO)				41982*	0.9
Holden	Vectra	JR	06/97	08/98	4	2.0L	C20SEL		41629		41969*	0.9
Holden	Vectra	JR	06/97	08/98	6	2.5L	X25XE		41629		41969*	0.9
Holden	Vectra	JS	08/98	2001	4	2.0L	C20SEL		41629		41969*	0.9
Holden	Vectra	JS	08/98	2001	6	2.5L	X25XE		41629		41969*	0.9
Holden	Vectra	JS Series I	08/98	1999	4	2.2L	C22SEL	16V DOHC	41629		41969*	0.9
Holden	Vectra	JS Series II	07/99	2003	4	2.2L	C22SEL	16V DOHC			41806	0.9
Holden	Vectra	JS Series II	10/00	2003	6	2.6L	Y26SE		41629		41969*	0.9
Holden	Vectra	ZC	03/03	12/06	4	2.2L	Z22SE				41972*	1.0
Holden	Vectra	ZC	03/03	12/06	6	3.2L	Z32SE		41629		41969*	0.9
Holden	Viva	JF	10/05	2008	4	1.8L	F18D3 (LDA)	DOHC			41970*	0.8
Holden	Zafira	TT	06/01	2005	4	2.2L	Z22SE				41972*	0.9
HONDA												
Honda	Accord		1979	1981	4	1.6L		Single CARB	43XLS	AC4		0.8
Honda	Accord	SY	1981	1983	4	1.6L	EL		R42XLS	AC4	41804	1.1
Honda	Accord	SZ	1981	1983	4	1.6L	EL		R42XLS	AC4	41804	1.1
Honda	Accord		1982	1982	4	1.6L		Single CARB		AC4		1.1
Honda	Accord	AD	1983	1986	4	1.8L	ES		R42XLS	AC4	41804	1.1
Honda	Accord	AD	1983	1986	4	1.8L	ET		R42XLS	AC4	41804	1.1
Honda	Accord	CA	1985	1989	4	2.0L	A20A2		R42XLS	AC4	41804	1.1
Honda	Accord	CA	1987	1989	4	2.0L	A20A4		R42XLS	AC4	41804	1.1
Honda	Accord	CB	11/89	1993	4	2.2L	F22A	EFI	R5610		41806	1.1
Honda	Accord	Aerodeck	1992	1993	4	2.2L	F22A6	EFI	R5610		41806	1.1
Honda	Accord	CE	1993	1998	4	2.2L	F22B1				41806	1.1
Honda	Accord	CD	1994	1997	4	2.2L	F22B	EFI			41806	1.1
Honda	Accord	CG	1997	2003	6	3.0L	J30A1				41806	1.1
Honda	Accord	CG	12/97	2003	4	2.3L	F23A	VTi VTEC			41806	1.1
Honda	Accord		1998	2003	4	2.3L	F23Z2				41806	1.1
Honda	Accord	CK	1998	2003	6	3.0L	J30A1				41806	1.1
Honda	Accord		2001	2002	6	3.0L	J30A1				41806	1.1
Honda	Accord	Euro	2003	2008	4	2.4L	K24A3	LEV			41967*	1.1
Honda	Accord	CM VTi	06/03	2005	4	2.4L	K24A4				41806	1.1
Honda	Accord	CM	06/03	2007	6	3.0L	J30A4				41806	1.1
Honda	Accord	CM	2005	2007	4	2.4L	K24A8				41806	1.1
Honda	Accord		2006	2007	4	2.4L	K24A4	LEV			41967*	1.1
Honda	Accord		2006	2007	6	3.0L	J30A4	LEV			41967*	1.1
Honda	Accord	CP	02/08	04/13	6	3.5L	J35Z2				41968*	1.1
Honda	Accord	CP	02/08	04/13	4	2.4L	K24Z2	VTi			41968*	1.1
Honda	Accord	CU	06/08	on	4	2.4L	K24Z3	Euro			41968*	1.1
Honda	Accord	CW	2008	2018	4	2.4L	K24Z				41968*	1.1
Honda	Airwave	GJ	2005	2010	4	1.5L	L15A				41967*	1.3
Honda	City	VF	01/84	1986	4	1.2L	ER		R43XLS	AC4	41802	1.1

MAKE	MODEL	SERIES / BADGE	FROM	TO	CYLS	CAPACITY	ENGINE	ADDITIONAL INFORMATION	REGULAR	PLATINUM (RAPIDFIRE®)	DOUBLE PLATINUM	GAP (MM)#
Honda	City	GM	02/09	on	4	1.5L	L15A7	88kW			41967*	1.1
Honda	Civic	SB	03/73	1976	4	1.2L	EB1		42XLS			0.8
Honda	Civic	AN	1976	1978	4	1.5L	EW2		R42XLS	AC4	41804	1.1
Honda	Civic		1980	1981	4	1.3L		Single CARB	43XLS	AC4		0.8
Honda	Civic		1982	1983	4	1.3L		Single CARB		AC4		1.1
Honda	Civic	AK	1983	1988	4	1.5L	EW2		R42XLS	AC4	41804	1.1
Honda	Civic	AH	1984	1988	4	1.5L	EW2		R42XLS	AC4	41804	1.1
Honda	Civic	ED	1987	1993	4	1.5L	D15B4				41825	1.1
Honda	Civic	EE	05/88	05/89	4	1.5L	D15B4				41825	1.1
Honda	Civic	EG	1991	1995	4	1.5L	D15B7				41806	1.1
Honda	Civic	EG	1991	1995	4	1.5L	D15Z1				41806	1.1
Honda	Civic	EH	1991	1993	4	1.6L	D16A8		41602	AC5	41801	1.1
Honda	Civic	EG Breeze	11/91	1993	4	1.3L	D13B2	SOHC			41825	1.1
Honda	Civic	EG GL	11/91	1993	4	1.5L	D15B4	SOHC			41825	1.1
Honda	Civic	EG Si	11/91	1993	4	1.6L	D16A	DOHC			41825	1.1
Honda	Civic	EG	1993	1995	4	1.6L	D16Y1		41602	AC5	41801	1.1
Honda	Civic	EG Breeze	10/93	1995	4	1.5L	D15Z2	SOHC	41602	AC5	41801	1.1
Honda	Civic	EH	10/93	2000	4	1.6L	D16Y1	VTi	41602	AC5	41801	1.1
Honda	Civic	EK	1995	2001	4	1.6L	D16Y2		41602	AC5	41801	1.1
Honda	Civic	EK	1995	2001	4	1.6L	D16Y4				41806	1.1
Honda	Civic	EK	1995	2001	4	1.6L	D16Y5				41806	1.1
Honda	Civic	EK	10/95	2000	4	1.6L	B16A2	VTi-R	41602	AC5	41801	1.1
Honda	Civic	Coupe	01/96	2000	4	1.6L	D16Y8	3 door	41602	AC5	41801	1.1
Honda	Civic	EU	2000	2005	4	1.7L	D17A2				41967*	1.1
Honda	Civic	ES	10/00	01/06	4	1.7L	D17Z1				41967*	1.1
Honda	Civic	Hybrid ES9	03/04	2005	4	1.3L	LDA1		41629		41800	1.1
Honda	Civic	Hybrid	2006	01/12	4	1.3L	LDA2				41835*	1.1
Honda	Civic	Sport	01/06	01/12	4	2.0L	K20Z21				41967*	1.1
Honda	Civic	FD	02/06	01/12	4	1.8L	R18A1				41967*	1.1
Honda	Civic	FK	2006	2012	4	1.8L	R18A2				41967*	1.1
Honda	Civic	FN - Type R	07/07	2014	4	2.0L	K20Z4				41967*	1.1
Honda	Concerto		11/88	1991	4	1.6L	D16Z2				41825	1.1
Honda	Concerto		1991	1993	4	1.6L	D16Z				41825	1.1
Honda	CRV	RD1	09/97	1999	4	2.0L	B20B	94kW			41806	1.1
Honda	CRV	RD1	03/99	2001	4	2.0L	B20B	108kW			41806	1.1
Honda	CRV	RD7	12/01	2006	4	2.4L	K24A1				41967*	1.1
Honda	CRV		2007	10/12	4	2.4L	K24Z1				41967*	1.1
Honda	CRV	RM	11/12	on	4	2.4L	K24Z9				41968*	1.1
Honda	CRX	ED	11/87	1992	4	1.6L	D16A8				41825	1.1
Honda	CRX	EG	06/92	1998	4	1.6L	B16A		41602	AC5	41801	1.1
Honda	CRZ	ZF	2013	2018	4	1.5L	LEA3				41967*	1.3
Honda	Elysion	RR	2004	2018	6	3.0L	J30A				41967*	1.1
Honda	Fit	GD	2002	2017	4	1.5L	L15A				41967*	1.3
Honda	HRV		01/99	2001	4	1.6L	D16A	SOHC			41806	1.1
Honda	HRV	GH	01/99	2002	4	1.6L	D16W1				41806	1.1
Honda	Inspire	UC	2003	2005	6	3.0L	J30A				41967*	1.1

MAKE	MODEL	SERIES / BADGE	FROM	TO	CYLS	CAPACITY	ENGINE	ADDITIONAL INFORMATION	REGULAR	PLATINUM (RAPIDFIRE®)	DOUBLE PLATINUM	GAP (MM)#
Honda	Integra	DA	05/86	1989	4	1.6L	D16A3				41825	1.1
Honda	Integra	DA	06/89	1993	4	1.8L	B18A1				41806	1.1
Honda	Integra	DC2 VTi-R	07/93	2001	4	1.8L	B18C2		41602	AC5	41801	1.1
Honda	Integra	DC4 Gsi	07/93	2001	4	1.8L	B18B2				41806	1.1
Honda	Integra	DC	1999	2001	4	1.8L	B18B1				41806	1.1
Honda	Integra	DC5	08/01	2006	4	2.0L	K20A3				41806	1.1
Honda	Integra	DC5 Type R	08/01	2004	4	2.0L	K20A2				41967*	1.1
Honda	Integra	DC Type S	10/04	2006	4	2.0L	K20Z1				41967*	1.1
Honda	Jazz	GD	10/02	2008	4	1.3L	L13A1	Requires 8 Plugs	41602	AC5	41801	1.1
Honda	Jazz	GD VTi / VTi-S	10/02	2008	4	1.5L	L15A1				41967*	1.3
Honda	Jazz	GE	2008	on	4	1.3L	L13Z				41967*	1.1
Honda	Jazz	GE	2008	on	4	1.5L	L15A				41967*	1.3
Honda	Legend	KA	05/86	1987	6	2.5L	C25A				41825	1.1
Honda	Legend	KA	1987	1991	6	2.7L	C27A				41825	1.1
Honda	Legend	KA	03/91	1996	6	3.2L	C32A		41602	AC5	41801	1.1
Honda	Legend	KA9	05/96	12/04	6	3.5L	C35A		41602	AC5	41801	1.1
Honda	Legend	KB	2006	2008	6	3.5L	J35A8				41967*	1.1
Honda	Legend		08/08	on	6	3.7L	J37A2				41968*	1.0
Honda	MDX	YD18	04/03	2006	6	3.5L	J35A5				41967*	1.1
Honda	Mobilio	GB	2001	2008	4	1.5L	L15A				41967*	1.3
Honda	Mobilio	GK	2002	2008	4	1.5L	L15A				41967*	1.3
Honda	NSX	NA	01/91	01/05	6	3.0L	C30A		41602	AC5	41801	1.1
Honda	NSX	NA	04/97	01/05	6	3.2L	CA32A		41602	AC5	41801	1.1
Honda	Odyssey	RA	06/95	1998	4	2.2L	F22B				41806	1.1
Honda	Odyssey	RA	1998	2000	4	2.3L	F23A7				41806	1.1
Honda	Odyssey	RA	04/00	2004	4	2.3L	F23Z4				41806	1.1
Honda	Odyssey	RA	04/00	2004	6	3.0L	J30A3				41806	1.1
Honda	Odyssey	RB	06/04	2009	4	2.4L	K24A6				41967*	1.1
Honda	Odyssey	RB	04/09	2014	4	2.4L	K24Z2				41968*	1.1
Honda	Prelude	SN	1979	1981	4	1.6L		Single CARB	43XLS	AC4		0.8
Honda	Prelude	SN	1982	1982	4	1.6L		Single CARB		AC4		1.1
Honda	Prelude	AB	01/83	1985	4	1.8L	ES		R42XLS	AC4	41804	1.1
Honda	Prelude	BA	01/86	1987	4	2.0L	A20A4				41825	1.1
Honda	Prelude	BA	08/87	1991	4	2.0L	B20A6				41825	1.1
Honda	Prelude	BA	12/91	12/96	4	2.2L	F22A1				41806	1.1
Honda	Prelude	BA	12/91	1996	4	2.2L	F22B1				41806	1.1
Honda	Prelude	BB Si	12/91	1996	4	2.3L	H23A1				41806	1.1
Honda	Prelude	BB1 VTEC	02/94	1996	4	2.2L	H22A1				41806	1.1
Honda	Prelude	BB5 Si	01/97	2002	4	2.2L	F22Z6				41806	1.1
Honda	Prelude	BB6 VTi-R VTEC	01/97	2002	4	2.2L	H22A4				41806	1.1
Honda	Prelude	BB	11/98	07/02	4	2.2L	H22Z1				41806	1.1
Honda	S2000	AP11	08/99	2009	4	2.0L	F20C1		FR1LS			1.1
Honda	Stepwgn	RF	1996	2001	4	2.0L	B20B				41967*	1.1
Honda	Stepwgn	RG	2005	2009	4	2.0L	K20A				41967*	1.1

MAKE	MODEL	SERIES / BADGE	FROM	TO	CYLS	CAPACITY	ENGINE	ADDITIONAL INFORMATION	REGULAR	PLATINUM (RAPIDFIRE®)	DOUBLE PLATINUM	GAP (MM)#
Honda	Stream	RN	2000	2004	4	2.0L	K20A				41967*	1.3
HUMMER												
Hummer	H3		2007	2010	5	3.7L	LLR				41834*	1.1
HYUNDAI												
Hyundai	Accent	LC	06/00	2003	4	1.5L	G4ECX		41629		41800	1.1
Hyundai	Accent	LC	03/03	04/06	4	1.6L	G4ED2		41629		41800	1.1
Hyundai	Accent	LS	03/03	04/06	4	1.6L	G4ED2		41629		41800	1.1
Hyundai	Accent	MC	2006	2011	4	1.6L	ALPHA		41602		41801	1.0
Hyundai	Coupe	RD FX	1996	2002	4	2.0L	G4GFT		41629		41800	1.1
Hyundai	Coupe	RD SFX	1996	2002	4	2.0L	G4GFT		41629		41800	1.1
Hyundai	Coupe	RD SX	07/96	2002	4	1.8L	G4GMT		41629		41800	1.1
Hyundai	Elantra	XD	10/00	2003	4	1.8L	G4GBX		41629		41800	1.1
Hyundai	Elantra	XD	10/00	2003	4	2.0L	G4GCX		41629		41800	1.1
Hyundai	Elantra	XD HVT	06/03	2006	4	2.0L	G4GC		41629		41800	1.1
Hyundai	Elantra	HD	2006	05/11	4	2.0L	G4GC6				41800	1.1
Hyundai	Elantra	MD	2012	2016	4	1.8L	G4NB				41968*	1.1
Hyundai	Excel	X1	02/86	1989	4	1.5L	G4GC6	CARB	R42XLS	AC4	41804	0.8
Hyundai	Excel	X2	01/90	1994	4	1.5L	G4DJ	EFI		AC4	41804	1.1
Hyundai	Excel	X3	10/94	1998	4	1.5L	Alpha II	SOHC	41629		41800	1.1
Hyundai	Excel	X3	01/98	2000	4	1.5L	G4FK	DOHC	41629		41800	1.1
Hyundai	Getz	TB	09/02	2005	4	1.5L	G4EC2		41629		41800	1.1
Hyundai	Getz	TB	03/03	2005	4	1.3L	G4EA2		41629		41800	1.1
Hyundai	Getz	TB	2005	2011	4	1.4L	G4EE		41629		41800	1.1
Hyundai	Getz	TB	2005	2011	4	1.6L	G4ED		41629		41800	1.1
Hyundai	Grandeur	FT4	09/99	2003	6	3.0L	G6CTX		41629		41800	1.1
Hyundai	Grandeur	TG	2006	on	6	3.8L	G6DA				41800	1.0
Hyundai	i30	FD	10/07	2013	4	2.0L	G4GC	DOHC	41629		41800	1.1
Hyundai	i30	FD	2008	2012	4	1.6L	G4FC				41967*	1.1
Hyundai	i30	GD	05/12	on	4	1.8L	G4NB				41968*	1.0
Hyundai	i40	VF	10/11	on	4	2.0L	G4NC				41968*	1.0
Hyundai	i45	YF	2010	2012	4	2.0L	G4KD				41835*	1.0
Hyundai	i45	YF	2013	2018	4	2.0L	G4NA				41968*	1.1
Hyundai	iload	TQ	2008	on	4	2.4L	G4KG8				41835*	1.1
Hyundai	imax	TQ	2008	on	4	2.4L	G4KG8				41835*	1.1
Hyundai	iX35	IM	2010	on	4	2.0L	G4KD				41835*	1.1
Hyundai	iX35	IM	2010	on	4	2.4L	G4KE				41835*	1.0
Hyundai	iX35	IM	2013	2015	4	2.0L	G4NC				41968*	1.1
Hyundai	Lantra	J1	05/91	1995	4	1.6L	G4CR			AC4	41804	1.1
Hyundai	Lantra	J1	05/91	1995	4	1.8L	G4CN			AC4	41804	1.1
Hyundai	Lantra	J2	03/95	1999	4	1.8L	G4GMR	DOHC	41629		41800	1.1
Hyundai	Lantra	J3	03/99	2000	4	1.8L	G4GMR	DOHC	41602	AC5	41801	1.1
Hyundai	Lantra	J3	03/99	2000	4	2.0L	G4GFV	DOHC	41629		41800	1.1
Hyundai	Lavita	PN8	10/01	2004	4	1.8L	G4GB		41629		41800	1.1
Hyundai	S Coupe		07/90	1992	4	1.5L	G4DJ		R42XLS	AC4	41804	1.1
Hyundai	S Coupe		10/92	1996	4	1.5L	G4EK		41629		41800	1.1
Hyundai	S Coupe		10/92	1995	4	1.5L	G4EKT		41602	AC5	41970*	0.9
Hyundai	Santa Fe		11/00	2003	4	2.4L	G4DSX	DOHC	R43XLS	AC4	41802	1.1
Hyundai	Santa Fe	CM	11/00	05/06	6	2.7L	G6EA		41629		41800	1.1

MAKE	MODEL	SERIES / BADGE	FROM	TO	CYLS	CAPACITY	ENGINE	ADDITIONAL INFORMATION	REGULAR	PLATINUM (RAPIDFIRE®)	DOUBLE PLATINUM	GAP (MM)#
Hyundai	Santa Fe	SB8	11/00	2003	4	2.4L	G4JSX	DOHC	R43XLS	AC4	41802	1.1
Hyundai	Santa Fe	CM	2006	2009	6	2.7L	G6EA				41835*	1.1
Hyundai	Santa Fe	CM	2007	2008	6	3.3L	G6DB				41800	1.1
Hyundai	Santa Fe	CM	11/09	08/12	6	3.5L	G6DC				41968*	1.1
Hyundai	Santa Fe	DM	2013	2018	6	3.3L	G6DF				41968*	1.1
Hyundai	Sonata		03/89	1992	4	2.4L	G4CS		R42XLS	AC4	41804	1.1
Hyundai	Sonata	EF	10/93	1998	4	2.0L	G4CP		R42XLS	AC4	41804	1.1
Hyundai	Sonata	EF	03/95	1998	6	3.0L	G6AT		R43XLS	AC4	41802	1.1
Hyundai	Sonata	EF	1998	2000	4	2.0L	G4JP		R42XLS	AC4	41804	1.1
Hyundai	Sonata	EF	08/98	2001	6	2.5L	G6BV		41629		41800	1.1
Hyundai	Sonata	EF-B	10/01	2005	4	2.4L	G4JSY		R43XLS	AC4	41802	1.1
Hyundai	Sonata	EF-B	10/01	2005	6	2.7L	G6BA		41629		41800	1.1
Hyundai	Sonata	NF	06/05	2009	4	2.4L	G4KC4		41629		41800	1.1
Hyundai	Sonata	NF	06/05	2008	6	3.3L	G6DB4S		41629		41800	1.1
Hyundai	Terracan	HP	12/01	2007	6	3.5L	G6CU		41629		41800	1.1
Hyundai	Tiburon	HN61D	02/02	2004	4	2.0L	G4GCI		41602	AC5	41801	1.1
Hyundai	Tiburon	HN61F	02/02	2008	6	2.7L	G6BA1		41602	AC5	41801	1.1
Hyundai	Trajjet	MG81C	07/00	2007	6	2.7L	G6BAX		41629		41800	1.1
Hyundai	Tucson	JN81	08/04	2009	6	2.7L	G6BA3		41629		41800	1.1
Hyundai	Tucson		2005	2010	4	2.0L	G4GC				41800	1.0
Hyundai	Tucson	TL	2015	2018	4	2.0L	G4NC				41968*	1.1
Hyundai	Tucson	TLE	2015	2018	4	2.0L	G4NA				41968*	1.1
INFINITI												
Infiniti	FX	S51 50	2012	2013	8	5.0L	VK50VE				41964*	1.1
Infiniti	M 35h	Y51	2012	2013	6	3.5L	VQ35HR				41964*	1.1
Infiniti	Q50	V37 HYBRID	2014	2018	6	3.5L	VQ35HR				41964*	1.1
Infiniti	QX70	S51	2014	2018	8	5.0L	VK50VE				41964*	1.1
JAGUAR												
Jaguar	340		1968	1969	6	3.4L			R43XLS	AC4		0.8
Jaguar	420		1966	1971	6	4.2L			R43XLS	AC4		0.8
Jaguar	MK 10		1962	1965	6	3.8L			R43XLS	AC4		0.8
Jaguar	MK 10		1965	1966	6	4.2L			R43XLS	AC4		0.8
Jaguar	S Type		1999	2008	6	3.0L			R44LTS6		41942	1.3
Jaguar	S Type		05/99	2002	6	3.0L	TA		R44LTS6		41942	1.3
Jaguar	S Type		05/99	2002	8	4.0L	AJ28				41800	1.3
Jaguar	S Type		06/02	2007	8	4.2L					41800	1.3
Jaguar	S Type		01/03	on	6	3.0L	TA		R42LTS		41963*	1.3
Jaguar	X Type		09/01	2005	6	2.5L			R42LTS		41963*	1.3
Jaguar	X Type		09/01	2010	6	3.0L			R42LTS		41963*	1.3
Jaguar	X Type		05/02	on	6	2.1L			R42LTS		41963*	1.3
Jaguar	XJ12		1976	1979	12	5.3L	7P		R42LTS		41810	0.9
Jaguar	XJ12		1976	1979	12	5.3L	7P		R43XLS	AC4		0.8
Jaguar	XJ12		1982	1985	12	5.3L			R42LTS		41810	0.9
Jaguar	XJ12		10/93	12/95	12	6.0L	8D		R42LTS		41810	0.9
Jaguar	XJ6		04/69	1973	6	2.8L	7G		R42XLS	AC4	41804	0.8
Jaguar	XJ6		1975	1986	6	3.4L			R43XLS	AC4		0.8
Jaguar	XJ6		03/87	1989	6	3.6L			41629		41969*	0.9

MAKE	MODEL	SERIES / BADGE	FROM	TO	CYLS	CAPACITY	ENGINE	ADDITIONAL INFORMATION	REGULAR	PLATINUM (RAPIDFIRE®)	DOUBLE PLATINUM	GAP (MM)#
Jaguar	XJ6		10/91	1997	6	3.2L					41825	0.9
Jaguar	XJ8		11/97	2003	8	3.2L	AJ6				41800	1.3
Jaguar	XJ8		11/97	2003	8	4.0L	AJ26				41800	1.3
Jaguar	XJ8	X350	07/03	04/09	8	3.5L	AJ				41800	1.3
Jaguar	XJ8	X350	07/03	03/10	8	4.2L	AJ				41800	1.3
Jaguar	XJ8R		09/97	02/00	8	4.0L		Supercharged		AC5	41801	1.3
Jaguar	XJ8R		03/00	03/02	8	4.0L		Supercharged	41629		41800	1.1
Jaguar	XJR		11/94	1997	6	4.0L			41602	AC5	41970*	0.9
Jaguar	XJR		1996	on	8	4.0L		Supercharged	FR1LS			0.9
Jaguar	XJR		11/97	2003	8	4.0L		Supercharged		AC5	41801	1.3
Jaguar	XJR		07/03	04/09	8	4.2L	AJ	Supercharged		AC5	41801	1.3
Jaguar	XJRS		11/92	1993	12	6.0L	8W		R42LTS		41810	0.9
Jaguar	XJS		09/76	1981	12	5.3L	7P		R43XLS	AC4		0.8
Jaguar	XJS	HE	1986	09/99	12	5.3L	8S		R42LTS		41810	0.9
Jaguar	XJS		11/92	1996	6	4.0L			41629		41969*	0.9
Jaguar	XK8		10/96	1998	8	4.0L	AJ27		41629		41800	1.0
Jaguar	XK8		05/98	2002	8	4.0L	AJ27				41800	1.3
Jaguar	XK8		10/02	2007	8	4.0L	AJ		41629		41800	1.0
Jaguar	XKR		05/98	2003	8	4.0L				AC5	41801	1.3
Jaguar	XKR		10/02	12/09	8	4.2L	AJ				41800	1.3
JEEP												
Jeep	Cherokee	KJ	09/01	2005	6	3.7L			41602	AC5	41970*	0.9
Jeep	Cherokee	KJ	02/04	01/06	4	2.4L	ED1				41973*	1.1
Jeep	Cherokee	KJ	07/05	2007	6	3.7L					41982*	0.9
Jeep	Cherokee	KK - Limited	03/08	04/13	6	3.7L	8W				41967*	1.1
Jeep	Cherokee	KK - Sport	03/08	04/13	6	3.7L	8W				41967*	1.1
Jeep	Cherokee	KL	2014	2018	6	3.2L	3.2				41968*	1.1
Jeep	Commander	XH	05/06	on	8	4.7L	3Y5				41967*	1.1
Jeep	Commander		05/06	03/10	8	5.7L	EZB	PCQ = 8			41973*	1.1
Jeep	Compass		02/07	on	4	2.4L	8D	16V DOHC			41967*	1.1
Jeep	Compass	MK	2007	2018	4	2.4L	ED3				41967*	1.1
Jeep	Compass	MK	2013	2018	4	2.0L	ECN				41967*	1.1
Jeep	Grand Cherokee	WJ	06/99	2005	8	4.7L	XY	SOHC			41806	1.1
Jeep	Grand Cherokee	WG	02/02	2005	8	4.7L	N	SOHC	FR1LS			1.0
Jeep	Grand Cherokee	WH	2005	2010	8	4.7L	HO (J)	SOHC			41806	1.0
Jeep	Grand Cherokee	WH	2005	2011	8	5.7L	Hemi				41973*	1.1
Jeep	Grand Cherokee	WH	06/05	03/10	8	4.7L	XY				41806	1.1
Jeep	Grand Cherokee	WK	2011	2018	6	3.6L	ERB				41968*	1.0
Jeep	Patriot		07/07	09/09	4	2.4L	8D	16V DOHC			41806	1.1
Jeep	Patriot	MK	2012	2018	4	2.0L	ACD				41967*	1.1
Jeep	Wrangler	JK	2012	2018	6	3.6L	ERB				41968*	1.1
KIA												
Kia	Carens		07/00	2002	4	1.8L	TB		41602		41970*	0.8
Kia	Carnival		09/99	2003	6	2.5L	K5		41602	AC5	41801	1.1
Kia	Carnival	KVII	10/03	2006	6	2.5L	K5		41602	AC5	41801	1.1
Kia	Carnival	VQ	08/06	05/10	6	2.7L	G6EA				41835*	1.1
Kia	Carnival	VQ	2010	2011	6	2.7L	G6EA				41968*	1.1
Kia	Carnival	YP	2015	2018	6	3.3L	G6DH				41968*	1.1

MAKE	MODEL	SERIES / BADGE	FROM	TO	CYLS	CAPACITY	ENGINE	ADDITIONAL INFORMATION	REGULAR	PLATINUM (RAPIDFIRE®)	DOUBLE PLATINUM	GAP (MM)#
Kia	Cerato	FE	07/04	2006	4	2.0L	G4GC		41629		41800	1.1
Kia	Cerato	TD	2009	on	4	2.0L	G4KD				41835*	1.0
Kia	Cerato	YD	04/13	on	4	2.0L	G4NC				41968*	1.1
Kia	Cerato	YD	04/13	on	4	1.8L	G4NB				41968*	1.1
Kia	Cerato	YD	2013	2018	4	2.0L	G4NA				41968*	1.1
Kia	Credos		05/98	2001	4	2.0L	FED		41602	AC5	41801	1.1
Kia	Grand Carnival	VQ	10/06	2010	6	3.8L	G6DA		41602	AC5	41801	1.1
Kia	Grand Carnival	VQ	06/10	04/11	6	3.5L	G6DC				41968*	1.1
Kia	Grand Carnival	VQ	05/11	on	6	3.5L	G6DC				41968*	1.1
Kia	Magentis	MG	08/06	03/10	4	2.4L	G4KC		41629		41800	1.1
Kia	Mentor	FA	12/96	1998	4	1.5L	B5	SOHC	R43XLS	AC4	41802	1.1
Kia	Mentor	FB SII	05/97	2000	4	1.5L	BFE	DOHC	41602	AC5	41801	1.1
Kia	Mentor	FB SII	05/98	2000	4	1.8L	TE	DOHC	41629		41969*	0.8
Kia	Optima		06/00	2003	6	2.5L	G6BV		41629		41800	1.1
Kia	Optima		05/04	2007	6	2.7L			41629		41800	1.1
Kia	Optima	GD	2001	2003	4	2.0L	G4JP				41966*	1.1
Kia	Rio	BC	07/00	2005	4	1.5L	A5D		41602	AC5	41801	1.1
Kia	Rio	JB	08/05	08/11	4	1.6L	G4ED		41602		41970*	0.8
Kia	Rio		2007	08/11	4	1.4L	G4EE		41629		41800	1.1
Kia	Rondo	UN - EX, LX	04/08	09/10	4	2.0L	G4KA		41629			1.1
Kia	Rondo	UN - Si, Sli	10/10	2014	4	2.0L	G4KA		41629			1.1
Kia	Rondo	RP	06/13	on	4	2.0L	G4NC				41968*	1.0
Kia	Shuma	FB	04/00	2001	4	1.8L	TE	DOHC	41602	AC5	41801	1.1
Kia	Sorento		02/03	09/07	6	3.8L	G6DA		41629		41800	1.1
Kia	Sorento	BL	02/03	2008	6	3.5L	G6CU		41629		41800	1.1
Kia	Sorento		09/07	2009	6	3.3L	G6DB6		41629		41969*	0.8
Kia	Sorento	XM	2009	07/11	4	2.4L	G4KE9				41835*	1.1
Kia	Sorento	XM	08/11	on	6	3.5L	G6DC				41968*	1.1
Kia	Sorento	UM	2015	2018	6	3.3L	G6DF				41968*	1.1
Kia	Soul	AM	11/11	01/14	4	2.0L	G4NA				41968*	1.1
Kia	Soul	PS	2014	2018	4	2.0L	G4NA				41968*	1.1
Kia	Spectra	FB	05/01	2004	4	1.8L	TE		41602	AC5	41801	1.1
Kia	Sportage	JA	12/96	2004	4	2.0L	FE	DOHC	41602	AC5	41966*	1.1
Kia	Sportage	KM	04/05	2009	6	2.7L	G6BA	DOHC	41629		41800	1.1
Kia	Sportage	KM2	2007	2010	4	2.0L	G4GC				41800	1.1
Kia	Sportage	SL	2010	on	4	2.0L	G4KD				41835*	1.1
Kia	Sportage	SL	2010	05/13	4	2.4L	G4KE				41835*	1.1
Kia	Sportage	QL	2016	2018	4	2.0L	G4NA				41968*	1.1
LADA												
Lada	Cevaro	Hatch	1990	1993	4	1.5L			R42XLS	AC4	41804	0.8
Lada	Niva		1994	1999	4	1.6L			R42XLS	AC4	41804	0.8
Lada	Niva		1995	1999	4	1.7L			R42XLS	AC4	41804	0.8
Lada	Sable		1994	1995	4	1.5L			R42XLS	AC4	41804	0.8
Lada	Samara		1988	1990	4	1.3L			R42XLS	AC4	41804	0.8
Lada	Samara		1988	1996	4	1.5L			R42XLS	AC4	41804	0.8
Lada	Volante		1993	1996	4	1.5L			R42XLS	AC4	41804	0.8

MAKE	MODEL	SERIES / BADGE	FROM	TO	CYLS	CAPACITY	ENGINE	ADDITIONAL INFORMATION	REGULAR	PLATINUM (RAPIDFIRE®)	DOUBLE PLATINUM	GAP (MM)#
LANDROVER												
Landrover	Discovery		03/91	1993	8	3.5L		EFI With 13/16"hex	R43XLS	AC4		0.8
Landrover	Discovery		1993	1999	8	3.9L		EFI With 13/16"hex	R43XLS	AC4		0.8
Landrover	Discovery		02/99	2005	8	4.0L		With 5/8"hex	41629		41800	1.0
Landrover	Discovery		04/05	09/09	8	4.4L			41629		41800	1.0
Landrover	Freelander		03/98	2000	4	1.8L	18K4FJ		41602	AC5	41801	1.1
Landrover	Freelander		11/00	2004	6	2.5L	25K4F		41602	AC5	41801	1.0
Landrover	Range Rover		01/76	1986	8	3.5L		CARB Leaded	R43XLS	AC4		0.8
Landrover	Range Rover		1985	12/89	8	3.5L	22D	Unleaded	R42XLS	AC4	41804	0.8
Landrover	Range Rover		1985	12/89	8	3.5L	23D	Unleaded	R42XLS	AC4	41804	0.8
Landrover	Range Rover		1989	1994	8	3.9L	37D		R43XLS	AC4	41802	0.9
Landrover	Range Rover		1989	1995	8	3.9L	38D		R43XLS	AC4	41802	0.9
Landrover	Range Rover		1995	1999	8	4.6L		With 13/16" hex	R43XLS	AC4	41802	0.9
Landrover	Range Rover		1999	2001	8	4.6L		EFI With 5/8"hex	41629		41800	1.1
Landrover	Range Rover		08/02	07/05	8	4.4L	M62B44		41629		41800	1.1
Landrover	Range Rover		08/05	09/09	8	4.4L	448PN		41629		41800	1.1
LEXUS												
Lexus	CT200h	ZWA10R - Hybrid	02/11	2014	4	1.8L	2ZRFXE				41964*	1.0
Lexus	ES300	VCV10R	05/92	1996	6	3.0L	3VZFE		41602	AC5	41801	1.1
Lexus	ES300	MCV20R	10/96	09/01	6	3.0L	1MZFE		41602	AC5	41801	1.1
Lexus	ES300	MCV30R	2001	2008	6	3.0L	1MZFE				41966*	1.1
Lexus	ES350	GSV60R	11/13	0N	6	3.5L	2GRFSE				41835*	1.1
Lexus	GS300	JZS160R	10/97	03/05	6	3.0L	2JZGE				41806	1.1
Lexus	GS350		04/12	on	6	3.5L	2GRFSE				41835*	1.1
Lexus	GS430	UZS161	1998	02/08	8	4.3L	3UZFE		41602	AC5	41801	1.1
Lexus	GS430	UZS190R	2005	2008	8	4.3L	3UZFE				41966*	1.1
Lexus	GS450H		05/06	03/12	6	3.5L	2GRFSE	Hybrid			41835*	1.1
Lexus	GS460		03/08	03/12	8	4.6L	1URFSE				41835*	1.1
Lexus	IS200	GXE10R	03/99	2005	6	2.0L	1GZFE		41602	AC5	41966*	1.1
Lexus	IS250	GSE20R	11/05	2011	6	2.5L	4GRFSE	153kW			41835*	1.1
Lexus	IS250C	GSE20R	07/09	2011	6	2.5L	4GRFSE	Convertible 153kW			41835*	1.1
Lexus	IS300	JCE10R	09/01	10/05	6	3.0L	2JZGE		41629		41800	1.1
Lexus	IS350		10/10	on	6	3.5L	2GRFSE				41835*	1.1
Lexus	IS-F		10/08	on	8	5.0L	2URGSE				41835*	1.1
Lexus	LS400	UCF10	04/90	1996	8	4.0L	1UZFE		41602	AC5	41801	1.1
Lexus	LS400	UCF20	08/96	2000	8	4.0L	1UZFE		41602	AC5	41801	1.1
Lexus	LS430	UCF30	12/00	03/07	8	4.3L	3UZFE		41602	AC5	41966*	1.1
Lexus	LS460		04/07	on	8	4.6L	1URFSE				41835*	1.1
Lexus	LS600H		11/07	12/12	8	5.0L	2URFSE				41835*	1.1
Lexus	LS600HL		02/13	on	8	5.0L	2URFSE				41835*	1.1
Lexus	LX470	UZJ100	05/98	03/08	8	4.7L	2UZFE		41602	AC5	41966*	1.1
Lexus	RX330	MCU36J	04/03	01/06	6	3.3L	3MZFE		41602	AC5	41801	1.1
Lexus	RX350	GSU35R	02/06	01/09	6	3.5L	2GRFE				41835*	1.1

MAKE	MODEL	SERIES / BADGE	FROM	TO	CYLS	CAPACITY	ENGINE	ADDITIONAL INFORMATION	REGULAR	PLATINUM (RAPIDFIRE®)	DOUBLE PLATINUM	GAP (MM)#
Lexus	RX300	MCU10R	2000	2003	6	3.0L	1MZFE				41966*	1.1
Lexus	RX300	MCU31	2003	2006	6	3.0L	1MZFE				41966*	1.1
Lexus	RX300	MCU38R	2003	2006	6	3.3L	3MZFE				41966*	1.1
Lexus	RX350	GGL15R	02/09	on	6	3.5L	2GRFE				41835*	1.1
Lexus	RX400H	MHU38R	2006	2008	6	3.3L	3MZFE				41966*	1.1
Lexus	SC400	UZZ30R	1991	2000	8	4.0L	1UZFE				41966*	1.1
Lexus	RX450H	GYL15R	06/09	10/15	6	3.5L	2GRFE				41835*	1.1
Lexus	SC430	UZZ40R	10/01	07/10	8	4.3L	3UZFE		41602	AC5	41966*	1.1
LEYLAND												
Leyland	Austin	A99	1959	1962	6	2.9L			R43XLS	AC4		0.8
Leyland	Austin	Freeway	1962	1965	6	2.4L			R42XLS	AC4	41804	0.8
Leyland	Austin	1800	1965	1975	4	1.8L			R42XLS	AC4	41804	0.8
Leyland	Austin	Kimberley	1970	1973	6	2.2L			R42XLS	AC4	41804	0.8
Leyland	Austin	Tasman	1971	1973	6	2.2L			R42XLS	AC4	41804	0.8
Leyland	Austin Healey	Sprite	1958	1962	4	1.0L	948		R42XLS	AC4	41804	0.8
Leyland	Austin Healey	3000	1960	1968	6	2.9L			R43XLS	AC4		0.8
Leyland	Austin Healey	Sprite	1963	1967	4	1.1L	1098		R42XLS	AC4	41804	0.8
Leyland	Leyland	P76	1973	1976	6	2.6L			R42XLS	AC4	41804	0.8
Leyland	Marina		1972	1975	4	1.5L			R42XLS	AC4	41804	0.8
Leyland	Marina		1973	1974	4	1.8L			R42XLS	AC4	41804	0.8
Leyland	Marina		1973	1975	6	2.6L			R42XLS	AC4	41804	0.8
Leyland	Mini	Clubman	1967	1980	4	1.0L			R42XLS	AC4	41804	0.8
Leyland	Mini	Clubman	1971	1982	4	1.1L			R42XLS	AC4	41804	0.8
Leyland	Mini	Clubman	1971	1981	4	1.3L			R42XLS	AC4	41804	0.8
Leyland	Moke		1966	1982	4	1.0L			R42XLS	AC4	41804	0.8
Leyland	Moke		1969	1983	4	1.1L			R42XLS	AC4	41804	0.8
Leyland	Moke	Californian	1978	1983	4	1.3L			R42XLS	AC4	41804	0.8
Leyland	Morris	Mini	1959	1974	4	0.9L			R42XLS	AC4	41804	0.8
Leyland	Morris	Mini	1965	1982	4	1.0L			R42XLS	AC4	41804	0.8
Leyland	Morris	Mini	1965	1981	4	1.3L			R42XLS	AC4	41804	0.8
Leyland	Morris	1100S	1967	1969	4	1.3L			R42XLS	AC4	41804	0.8
Leyland	Morris	1300	1967	1975	4	1.3L			R42XLS	AC4	41804	0.8
Leyland	Morris	1100	1968	1975	4	1.1L			R42XLS	AC4	41804	0.8
Leyland	Morris	1300 Nomad	1969	1972	4	1.3L			R42XLS	AC4	41804	0.8
Leyland	Morris	1500	1969	1972	4	1.5L			R42XLS	AC4	41804	0.8
Leyland	Morris	1500 Nomad	1969	1972	4	1.5L			R42XLS	AC4	41804	0.8
Leyland	Morris	Mini	1969	1982	4	1.1L			R42XLS	AC4	41804	0.8
Leyland	Morris	1300 GT	1970	1981	4	1.3L			R42XLS	AC4	41804	0.8
Leyland	Morris	Moke	1974	1982	4	1.0L			R42XLS	AC4	41804	0.8
Leyland	Wolseley	6/99	1960	1962	6	2.9L			R43XLS	AC4		0.8
Leyland	Wolseley	6/110	1962	1966	6	2.9L			R43XLS	AC4		0.8
Leyland	Wolseley	1300	1967	1975	4	1.3L			R43XLS	AC4		0.8
MAZDA												
Mazda	121		03/76	03/79	4	1.8L	VC		42XLS			0.8
Mazda	121		04/78	1980	4	2.0L	MA		42XLS			0.8
Mazda	121	DA	03/87	1990	4	1.3L	B3	Hatch	R43XLS	AC4	41802	1.1

MAKE	MODEL	SERIES / BADGE	FROM	TO	CYLS	CAPACITY	ENGINE	ADDITIONAL INFORMATION	REGULAR	PLATINUM (RAPIDFIRE®)	DOUBLE PLATINUM	GAP (MM)#
Mazda	121	DB	11/90	08/97	4	1.3L	B3		FR3LS		41800	1.1
Mazda	121	DB	01/94	12/96	4	1.5L	B5		FR3LS		41800	1.1
Mazda	121	DW	10/96	12/02	4	1.3L	B3		FR3LS		41800	1.1
Mazda	121	DW	10/96	12/02	4	1.5L	B5		FR3LS		41800	1.1
Mazda	323		1977	1985	4	1.3L			43XLS	AC4		0.8
Mazda	323		1978	1981	4	1.4L			43XLS	AC4		0.8
Mazda	323		1980	1985	4	1.5L			43XLS	AC4		0.8
Mazda	323	BF	10/85	10/89	4	1.6L	B6			AC4	41802	1.1
Mazda	323	BW	06/86	04/88	4	1.6L	B6			AC4	41802	1.1
Mazda	323	BF	10/87	1989	4	1.6L	B6	Turbo DOHC			41825	1.1
Mazda	323	Astina BG	10/89	08/94	4	1.8L	BP	DOHC	41602	AC5	41801	1.1
Mazda	323	Astina BG	10/89	1994	4	1.8L	BPE	SOHC	FR3LS		41800	1.1
Mazda	323	BG	10/89	1993	4	1.6L	B6	EFI DOHC	R43XLS	AC4	41802	1.1
Mazda	323	BG	10/89	1996	4	1.6L	B6	CARB SOHC	FR3LS		41800	1.1
Mazda	323	BG	10/89	1996	4	1.8L	BP	SOHC	R43XLS	AC4	41802	1.1
Mazda	323	Astina BA	07/94	09/98	4	1.8L	BP	DOHC	41602	AC5	41801	1.1
Mazda	323	Astina BA	07/94	1998	6	2.0L	KF	DOHC	41602	AC5	41801	1.1
Mazda	323	Protégé BA	07/94	1998	4	1.6L	B6	DOHC	FR3LS		41800	1.1
Mazda	323	Protégé BA	07/94	1998	4	1.8L	BP	DOHC	41602	AC5	41801	1.1
Mazda	323	Astina BJ10	09/98	2001	4	1.6L	ZMD				41806	1.1
Mazda	323	Astina BJ10	09/98	2001	4	1.8L	FPD		FR3LS		41800	1.1
Mazda	323	Protégé BJ10	09/98	2001	4	1.6L	ZMD				41806	1.1
Mazda	323	Protégé BJ10	09/98	2001	4	1.8L	FPD		41629		41800	1.1
Mazda	323	Astina BJ20	02/01	2004	4	1.6L	ZMD		41629		41800	1.1
Mazda	323	Astina BJ20	02/01	2004	4	1.8L	FPD		41602	AC5	41801	1.1
Mazda	323	Astina BJ20 SP	02/01	2004	4	2.0L	FS				41967*	1.1
Mazda	323	Protégé BJ20	02/01	2004	4	1.6L	FPD		41602	AC5	41801	1.1
Mazda	323	Protégé BJ20	02/01	2004	4	1.6L	ZMD		41629		41800	1.1
Mazda	323	Protégé BJ20 SP	02/01	2004	4	2.0L	FS				41967*	1.1
Mazda	626	CB2	11/78	1983	4	2.0L	MA		42XLS			0.8
Mazda	626	GC	1983	1987	4	2.0L	FE	Leaded	R43XLS	AC4		0.8
Mazda	626	GC	01/86	1987	4	2.0L	FE	Turbo Unleaded	R42XLS	AC4	41804	1.1
Mazda	626	GC	1986	1987	4	2.0L	FE	Unleaded	R43XLS	AC4	41802	1.1
Mazda	626	GD	10/87	1991	4	2.2L	F2				41806	1.1
Mazda	626	GV	06/88	1997	4	2.2L	F2	Wagon			41806	1.1
Mazda	626	GE	01/92	1997	4	2.0L	FS		FR3LS		41800	1.1
Mazda	626	GE	01/92	1997	6	2.5L	KLZE		R5610		41806	1.1
Mazda	626	GF	07/97	2002	4	2.0L	FSDE		41629		41800	1.1
Mazda	929		07/73	1979	4	1.8L	VC		42XLS			0.8

MAKE	MODEL	SERIES / BADGE	FROM	TO	CYLS	CAPACITY	ENGINE	ADDITIONAL INFORMATION	REGULAR	PLATINUM (RAPIDFIRE®)	DOUBLE PLATINUM	GAP (MM)#
Mazda	929	LA	1979	1982	4	2.0L	MA		42XLS			0.8
Mazda	929	HB	02/82	1987	4	2.0L	MA		R42XLS	AC4	41804	0.8
Mazda	929	HB	02/84	1985	4	2.0L	FE		R43XLS	AC4		0.8
Mazda	929	HB	01/86	1987	4	2.0L	FE	EFI	R43XLS	AC4	41802	1.1
Mazda	929	HB	01/86	1987	4	2.0L	FET	Turbo	R42XLS	AC4	41804	1.1
Mazda	929	HC	06/87	08/91	6	3.0L	JE		41629		41800	1.1
Mazda	929	HD	07/91	1996	6	3.0L	JEZE		41602	AC5	41801	1.1
Mazda	929	HE	04/96	1997	6	3.0L	JEZE				41806	1.1
Mazda	B1500		01/70	12/71	4	1.5L			R43XLS	AC4		0.8
Mazda	B1600	NA	07/71	1980	4	1.6L			R42XLS	AC4	41804	0.8
Mazda	B1600		1981	1983	4	1.6L			R43XLS	AC4		0.8
Mazda	B1800		1977	1983	4	1.8L	VC		R43XLS	AC4		0.8
Mazda	B2000		1982	1985	4	2.0L	MA		R43XLS	AC4		0.8
Mazda	B2000		1985	1988	4	2.0L	FE		R43XLS	AC4		0.8
Mazda	B2200		1988	1993	4	2.2L	F2		R43XLS	AC4		0.8
Mazda	B2600		1989	1989	4	2.6L			43XLS	AC4		0.8
Mazda	B2600		1990	1992	4	2.6L	AM		41602		41970*	0.8
Mazda	B2600	Bravo	04/90	11/06	4	2.6L	G6				41806	1.1
Mazda	Bongo Van	F1000	01/70	1978	4	1.0L	PB		R42XLS	AC4	41804	0.8
Mazda	Capella	SNA	10/70	1978	4	1.6L	NA		R42XLS	AC4	41804	0.8
Mazda	CX-7	ER Series 1	09/06	2009	4	2.3L	L3MZRDISI	Turbo			41972*	1.1
Mazda	CX-7	ER Series 2	2009	on	4	2.3L	L3MZRDISI	Turbo			41972*	1.1
Mazda	CX-7	ER Series 2	2009	on	4	2.5L	L5				41972*	1.1
Mazda	CX-9	TB	2007	on	6	3.7L	CA				41972*	1.1
Mazda	E1300		1978	1980	4	1.3L			43XLS	AC4		0.8
Mazda	E1400		1980	1983	4	1.4L			43XLS	AC4		0.8
Mazda	E1600		1978	1983	4	1.6L			43XLS	AC4		0.8
Mazda	E1800		1984	1988	4	1.8L			43XLS	AC4		0.8
Mazda	E2000		1974	1981	4	2.0L			43XLS	AC4		0.8
Mazda	E2000		10/99	2003	4	2.0L	FE		41602	AC5	41801	1.1
Mazda	E2000	SH	02/03	07/06	4	2.0L	FEE		41602	AC5	41801	1.1
Mazda	Eunos	30X EC	06/96	1997	6	1.8L	K8ZE		41602	AC5	41801	1.1
Mazda	Eunos	500 CA	06/96	1999	6	2.0L	KFZE				41800	1.1
Mazda	Eunos	800 TA	06/96	1998	6	2.5L	KLZE				41806	1.1
Mazda	Eunos	800M TA	06/96	2000	6	2.3L	KJ	Miller	41602	AC5	41801	1.1
Mazda	Mazda2	DY Series 1	12/02	2005	4	1.5L	ZYMZR		41629		41800	1.1
Mazda	Mazda2	DY Series 2	2005	2007	4	1.5L	ZYMZR				41800	1.1
Mazda	Mazda2	DE Series 1	2007	10/14	4	1.5L	ZYMZR		41602		41966*	1.1
Mazda	Mazda3	BK Series 1	2004	06/06	4	2.0L	LFDE	With 17.5mm Reach	R42LTS		41963*	1.3
Mazda	Mazda3	BK Series 1	2004	06/06	4	2.0L	LFDE	With 25mm Reach			41814	1.3
Mazda	Mazda3	BK Series 2 SP23	2004	06/06	4	2.3L	L3SVT	With 17.5mm Reach	R42LTS		41963*	1.3
Mazda	Mazda3	BK Series 2	07/06	03/09	4	2.0L	LFDE	With 25mm Reach			41814	1.3
Mazda	Mazda3	BK Series 2	07/06	03/09	4	2.0L	LFDE	With 17.5mm Reach			41963*	1.3

MAKE	MODEL	SERIES / BADGE	FROM	TO	CYLS	CAPACITY	ENGINE	ADDITIONAL INFORMATION	REGULAR	PLATINUM (RAPIDFIRE®)	DOUBLE PLATINUM	GAP (MM)#
Mazda	Mazda3	BK Series 2 SP23	07/06	03/09	4	2.3L	L3SVT	With 25mm Reach			41814	1.3
Mazda	Mazda3	BL Series 1	2009	on	4	2.0L	LFMZR				41834*	1.3
Mazda	Mazda3	BL Series 1 MPS	2009	on	4	2.3L	L3SVT	Turbo			41972*	1.1
Mazda	Mazda3	BL Series 1 SP25	2009	on	4	2.5L	L5SVT				41834*	1.3
Mazda	Mazda6	GG	08/02	2005	4	2.3L	LFMZR		R42LTS		41963*	1.3
Mazda	Mazda6	GY	08/02	2005	4	2.3L	LFMZR		R42LTS		41963*	1.3
Mazda	Mazda6	GG	2005	2007	4	2.3L	LFMZR				41814	1.3
Mazda	Mazda6	GY	2005	2007	4	2.3L	LFMZR				41814	1.3
Mazda	Mazda6	GH	2008	11/12	4	2.5L	L5				41814	1.2
Mazda	Millenia	TA	10/00	2002	6	2.3L	KJ	Miller			41982*	0.8
Mazda	MPV	LV10E1	09/93	1996	6	3.0L	JE				41806	1.1
Mazda	MPV	LV11E2	04/96	1999	6	3.0L	JE		41629		41800	1.1
Mazda	MPV	LW10G	08/99	2002	6	2.5L	GYDE		R42LTS		41810	1.1
Mazda	MPV	LWA2	06/02	09/06	6	3.0L	AJ		R42LTS		41963*	1.3
Mazda	MX5	NA	10/89	1993	4	1.6L	B6ZE		41602	AC5	41801	1.1
Mazda	MX5	NB	01/02	08/05	4	1.8L	B8ZTE	Turbo	41629		41800	1.1
Mazda	MX5	NB	12/02	08/05	4	1.8L	B8ZE	DOHC	FR3LS		41800	1.1
Mazda	MX5		09/05	on	4	2.0L	LF				41814	1.3
Mazda	MX6	GC	11/86	1987	4	2.0L		Turbo Unleaded	R42XLS	AC4	41804	1.1
Mazda	MX6	GD	11/87	1991	4	2.2L	F28	Turbo			41806	1.1
Mazda	MX6	GE	11/91	1997	6	2.5L	KLZE				41806	1.1
Mazda	Premacy	1.8L	02/00	2002	4	1.8L	FPDE		41629		41800	1.1
Mazda	Premacy	2.0L	04/02	2003	4	2.0L	FS		41629		41800	1.1
Mazda	T2000		05/81	1982	4	2.0L	VA		R42XLS	AC4	41804	0.8
Mazda	T2600		04/85	1988	4	2.6L	G54B		R42XLS	AC4	41804	0.8
Mazda	Tribute	YU06	02/01	2004	4	2.0L	YF	DOHC			41814	1.3
Mazda	Tribute	YU08	02/01	01/04	6	3.0L	AJ	DOHC	R42LTS		41963*	1.3
MERCEDES-BENZ												
Mercedes-Benz	220	W115	1968	1973	4	2.2L	M114		R42XLS	AC4	41804	0.8
Mercedes-Benz	230.4	W115	1974	1976	4	2.3L	M115		R42XLS	AC4	41804	0.8
Mercedes-Benz	230.6	W114	1973	1976	6	2.3L	M180		R42XLS	AC4	41804	0.8
Mercedes-Benz	250	W114	1968	1972	6	2.5L	M114		R42XLS	AC4	41804	0.8
Mercedes-Benz	250	W114	1972	1976	6	2.8L	M130		R42XLS	AC4	41804	0.8
Mercedes-Benz	250	W123	1977	1983	6	2.5L	M123		R42XLS	AC4	41804	0.8
Mercedes-Benz	280	W114	1972	1976	6	2.8L	M110		R42XLS	AC4	41804	0.8
Mercedes-Benz	220E	W124	1993	1995	4	2.2L	M111		41602		41970*	0.8
Mercedes-Benz	230E	W123	1980	1985	4	2.3L	M102		R6602		41810	0.9
Mercedes-Benz	230E	W124	1985	1993	4	2.3L	M102		R6602		41810	0.9
Mercedes-Benz	230TE	W123	1980	1985	4	2.3L	M102		R6602		41810	0.9
Mercedes-Benz	230TE	W124	1985	1993	4	2.3L	M102		R6602		41810	0.9
Mercedes-Benz	250C	W114	1969	1972	6	2.5L	M114		R42XLS	AC4	41804	0.8
Mercedes-Benz	250C	W114	1973	1976	6	2.8L	M130		R42XLS	AC4	41804	0.8
Mercedes-Benz	250CE	W114	1969	1972	6	2.5L	M114		R42XLS	AC4	41804	0.8
Mercedes-Benz	260E	W124	1986	1993	6	2.6L	M103		R6602		41810	0.9

MAKE	MODEL	SERIES / BADGE	FROM	TO	CYLS	CAPACITY	ENGINE	ADDITIONAL INFORMATION	REGULAR	PLATINUM (RAPIDFIRE®)	DOUBLE PLATINUM	GAP (MM)#
Mercedes-Benz	280C	W114	1972	1973	6	2.8L	M110		R42XLS	AC4	41804	0.8
Mercedes-Benz	280CE	W114	1972	1976	6	2.8L	M110		R42XLS	AC4	41804	0.8
Mercedes-Benz	280CE	W123	1977	1985	6	2.8L	M110		R42XLS	AC4	41804	0.8
Mercedes-Benz	280E	W114	1972	1976	6	2.8L	M110		R42XLS	AC4	41804	0.8
Mercedes-Benz	280E	W123	1976	1986	6	2.8L	M110		R42XLS	AC4	41804	0.8
Mercedes-Benz	280S	W116	1973	1980	6	2.8L	M110		R42XLS	AC4	41804	0.8
Mercedes-Benz	280SE	W116	1973	1981	6	2.8L	M110		R42XLS	AC4	41804	0.8
Mercedes-Benz	280SE	W126	1980	1986	6	2.8L	M110		R42XLS	AC4	41804	0.8
Mercedes-Benz	280SEL	W116	1975	1980	6	2.8L	M110		R42XLS	AC4	41804	0.8
Mercedes-Benz	280SEL	W126	1980	1986	6	2.8L	M110		R42XLS	AC4	41804	0.8
Mercedes-Benz	280SLC	R107	1975	1981	6	2.8L	M110		R42XLS	AC4	41804	0.8
Mercedes-Benz	280TE	S123	1980	1985	6	2.8L	M110		R42XLS	AC4	41804	0.8
Mercedes-Benz	300CE	W124	1987	1990	6	3.0L	M103		R42LTS		41810	0.9
Mercedes-Benz	300CE	W124	1990	1993	6	3.0L	M104		R42LTS		41810	0.9
Mercedes-Benz	300E	W124	1985	1992	6	3.0L	M103		R42LTS		41810	0.9
Mercedes-Benz	300E	W124	1986	1993	6	3.0L	M104		R42LTS		41810	0.9
Mercedes-Benz	300E	W124	1992	1995	6	2.8L	M104		R42LTS		41810	0.9
Mercedes-Benz	300SE	W126	1985	1992	6	3.0L	M103		R6602		41810	0.9
Mercedes-Benz	300SEL	W126	1986	1991	6	3.0L	M103		R6602		41810	0.9
Mercedes-Benz	300TE	W124	1987	1993	6	3.0L	M104		R42LTS		41810	0.9
Mercedes-Benz	350SE		1973	1976	8	3.5L	M116		R42XLS	AC4	41804	0.8
Mercedes-Benz	350SL		1971	1980	8	3.5L	M116		R42XLS	AC4	41804	0.8
Mercedes-Benz	350SLC		1973	1981	8	3.5L	M116		R42XLS	AC4	41804	0.8
Mercedes-Benz	380SE	W126	1981	1986	8	3.8L	M116		R42XLS	AC4	41804	0.8
Mercedes-Benz	380SEC	C126	1981	1986	8	3.8L	M116		R42XLS	AC4	41804	0.8
Mercedes-Benz	380SEL	W126	1980	1986	8	3.8L	M116		R42XLS	AC4	41804	0.8
Mercedes-Benz	380SL		1980	1986	8	3.8L	M116		R42XLS	AC4	41804	0.8
Mercedes-Benz	420SE	W126	1986	1991	8	4.2L	M116		R42XLS	AC4	41804	0.8
Mercedes-Benz	420SEL	W126	1986	1991	8	4.2L	M116		R42XLS	AC4	41804	0.8
Mercedes-Benz	450SE		1974	1981	8	4.5L	M117		R42XLS	AC4	41804	0.8
Mercedes-Benz	450SEL		1973	1981	8	4.5L	M117		R42XLS	AC4	41804	0.8
Mercedes-Benz	450SL		1974	1980	8	4.5L	M117		R42XLS	AC4	41804	0.8
Mercedes-Benz	450SLC		1973	1981	8	4.5L	M117		R42XLS	AC4	41804	0.8
Mercedes-Benz	500SEC	C140	1991	1993	8	5.0L	M119		41602		41970*	0.8
Mercedes-Benz	500SEC	W140	1991	1993	8	5.0L	M119		41602		41970*	0.8
Mercedes-Benz	500SL	R129	1989	1993	8	5.0L	M119		41602		41970*	0.8
Mercedes-Benz	560SEC	C126	1986	1991	8	5.6L	M117		R42XLS	AC4	41804	0.8
Mercedes-Benz	560SEL	W126	1986	1992	8	5.6L	M117		R42XLS	AC4	41804	0.8
Mercedes-Benz	560SL	R107	1986	1990	8	5.6L	M117		R42XLS	AC4	41804	0.8
Mercedes-Benz	600SEL	W140	1992	1993	12	6.0L	M120		41602		41970*	0.8
Mercedes-Benz	600SL	R129	1992	1994	12	6.0L	M120		41602		41970*	0.8
Mercedes-Benz	A140	W168	02/00	2001	4	1.4L	M166		41629		41969*	0.9
Mercedes-Benz	A150	W168	04/05	2007	4	1.5L	M266		41602	AC5	41970*	0.9
Mercedes-Benz	A160	W168	10/98	2005	4	1.6L	M166		41629		41969*	0.9
Mercedes-Benz	A190	W168	09/99	2005	4	1.9L	M166		41629		41969*	0.9
Mercedes-Benz	B200T	W245	2005	2012	4	2.0L	M266.980				41966*	1.0
Mercedes-Benz	C180	W202	02/94	1997	4	1.8L	M111		41629		41969*	0.8

MAKE	MODEL	SERIES / BADGE	FROM	TO	CYLS	CAPACITY	ENGINE	ADDITIONAL INFORMATION	REGULAR	PLATINUM (RAPIDFIRE®)	DOUBLE PLATINUM	GAP (MM)#
Mercedes-Benz	C180	W202	02/97	2000	4	1.8L	M111		41602	AC5	41970*	0.9
Mercedes-Benz	C180	W203	11/00	09/02	4	2.0L	M111		41602	AC5	41966*	1.0
Mercedes-Benz	C180	CL203	12/01	09/02	4	2.0L	M111		41602	AC5	41966*	1.0
Mercedes-Benz	C180	S203	2000	2002	4	1.8L	M111.951				41966*	1.0
Mercedes-Benz	C200	S202	01/96	1997	4	2.0L	M111		41629		41969*	0.8
Mercedes-Benz	C200	W202	01/96	1997	4	2.0L	M111		41629		41969*	0.8
Mercedes-Benz	C200	S202	07/97	2000	4	2.0L	M111		41629		41969*	0.9
Mercedes-Benz	C200	W202	07/97	2000	4	2.0L	M111		41629		41969*	0.9
Mercedes-Benz	C200	W202	2000	2001	4	2.0L	M111.956				41966*	1.0
Mercedes-Benz	C200K	W203	2000	2002	4	2.0L	M111	Supercharged	41602	AC5	41966*	1.0
Mercedes-Benz	C200K	CL203	2001	2002	4	2.0L	M111	Supercharged	41602	AC5	41966*	1.0
Mercedes-Benz	C200K	S203	2001	2002	4	2.0L	M111	Supercharged	41602	AC5	41966*	1.0
Mercedes-Benz	C200K	S203	2002	2007	4	1.8L	M271	Supercharged	41602	AC5	41801	1.1
Mercedes-Benz	C200K	W203	2002	2007	4	1.8L	M271	Supercharged	41602	AC5	41801	1.1
Mercedes-Benz	C220	W202	03/94	1996	4	2.2L	M111		41629		41969*	0.8
Mercedes-Benz	C230	W202	11/96	1997	4	2.3L	M111		41629		41969*	0.8
Mercedes-Benz	C240	S202	1997	2000	6	2.4L	M112		41629		41800	1.1
Mercedes-Benz	C240	S203	2000	2005	6	2.4L	M112.912	PCQ = 12			41966*	1.0
Mercedes-Benz	C240	W202	1997	2000	6	2.4L	M112.910	PCQ = 12	41629		41800	1.1
Mercedes-Benz	C240	W203	11/00	2005	6	2.6L	M112		41629		41800	1.0
Mercedes-Benz	C280	W202	02/94	1997	6	2.8L	M104		41629		41969*	0.8
Mercedes-Benz	C280	W202	08/97	2000	6	2.8L	M112.920	PCQ = 12	41629		41800	1.0
Mercedes-Benz	C32 AMG	S203	2001	2005	6	3.2L	M112.961	PCQ = 12			41966*	1.0
Mercedes-Benz	C32 AMG	W203	11/01	08/04	6	3.2L	M112		41602	AC5	41966*	1.0
Mercedes-Benz	C320	CL203	2004	2005	6	3.2L	M112.946	PCQ = 12			41966*	1.0
Mercedes-Benz	C320	S203	2001	2005	6	3.2L	M112.946	PCQ = 12			41966*	1.0
Mercedes-Benz	C320	W203	11/00	2005	6	3.2L	M112		41629		41800	1.0
Mercedes-Benz	C36 AMG	W202	10/95	1997	6	3.6L	M104.941	PCQ = 12	41629		41969*	0.8
Mercedes-Benz	C43 AMG	W202	04/98	2000	8	4.3L	M113.944	PCQ = 16	41629		41800	1.0
Mercedes-Benz	CL500	C140	11/96	1998	8	5.0L	M119	Coupe	41629		41969*	0.8
Mercedes-Benz	CL500	C215	03/00	03/07	8	5.0L	M113.960	Coupe PCQ = 16	41629		41969*	0.8
Mercedes-Benz	CL55 AMG	C215	10/01	2003	8	5.4L	M113.991	PCQ = 16	41629		41800	1.0
Mercedes-Benz	CL600	C215	03/00	2003	12	5.8L	M137	Coupe PCQ = 24	41629		41800	1.0
Mercedes-Benz	CL600	C215	03/03	07/07	12	5.5L		Coupe Turbo	41629		41969*	0.8
Mercedes-Benz	CLK200	C208	10/97	2000	4	2.0L	M111		41629		41969*	0.8
Mercedes-Benz	CLK200K	A208	2000	2004	4	2.0L	M111.956				41966*	1.0
Mercedes-Benz	CLK200K	C208	2000	2002	4	2.0L	M111.956				41966*	1.0
Mercedes-Benz	CLK230K	A208	2000	2004	4	2.3L	M111.982				41966*	1.0
Mercedes-Benz	CLK230K	C208	10/97	2002	4	2.3L	M111	Supercharged	41602	AC5	41966*	1.0
Mercedes-Benz	CLK240	A209	2003	2005	6	2.6L	M112.912	PCQ = 12			41966*	1.0
Mercedes-Benz	CLK240	C209	11/02	08/05	6	2.6L	M112		41629		41800	1.0
Mercedes-Benz	CLK320	C208	10/97	2002	6	3.2L	M112.940	PCQ = 12	41629		41800	1.0
Mercedes-Benz	CLK320	C209	06/02	08/05	6	3.2L	M112.955	PCQ = 12	41629		41800	1.0
Mercedes-Benz	CLK320	A209	06/03	08/05	6	3.2L	M112.955	PCQ = 12	41629		41800	1.0
Mercedes-Benz	CLK430	C208	11/99	2003	8	4.3L	M113.943	PCQ = 16	41629		41800	1.0
Mercedes-Benz	CLK500	C209	06/02	08/06	8	5.0L	M113.968	PCQ = 16	41629		41800	1.0

MAKE	MODEL	SERIES / BADGE	FROM	TO	CYLS	CAPACITY	ENGINE	ADDITIONAL INFORMATION	REGULAR	PLATINUM (RAPIDFIRE®)	DOUBLE PLATINUM	GAP (MM)#
Mercedes-Benz	CLK500	A209	06/03	08/06	8	5.0L	M113.968	PCQ = 16	41629		41800	1.0
Mercedes-Benz	CLK55 AMG	C208	02/00	2002	8	5.4L	M113.984	PCQ = 16	41629		41800	1.0
Mercedes-Benz	CLK55 AMG	C209	11/02	08/06	8	5.4L	M113.987	PCQ = 16	41629		41800	1.0
Mercedes-Benz	CLK55 AMG	A209	08/03	08/06	8	5.4L	M113.987	PCQ = 16	41629		41800	1.0
Mercedes-Benz	E200K	W210	08/00	2002	4	2.0L	M111	Supercharged	41602	AC5	41966*	1.0
Mercedes-Benz	E220	W124	06/93	1996	4	2.2L	M111		41602		41970*	0.8
Mercedes-Benz	E230	W210	1995	05/99	4	2.3L	M111		41629		41969*	0.8
Mercedes-Benz	E230	S210	10/96	05/98	4	2.3L	M111		41629		41969*	0.8
Mercedes-Benz	E240	W210	01/98	08/02	6	2.6L	M112.911	PCQ = 12	41629		41800	1.1
Mercedes-Benz	E240	S210	11/99	08/02	6	2.6L	M112.911	PCQ = 12	41629		41800	1.1
Mercedes-Benz	E240	W211	08/02	08/05	6	2.6L	M112.913	PCQ = 12	41629		41800	1.0
Mercedes-Benz	E280	S124	09/93	10/94	6	2.8L	M104		41602		41970*	0.8
Mercedes-Benz	E280	W124	09/93	02/96	6	2.8L	M104		41602		41970*	0.8
Mercedes-Benz	E280	W210	09/98	2001	6	2.8L	M112.921	PCQ = 12	41629		41800	1.1
Mercedes-Benz	E320	W124	09/93	1996	6	3.2L	M104		41602		41970*	0.8
Mercedes-Benz	E320	W210	02/96	1997	6	3.2L	M104.995	PCQ = 12	41629		41969*	0.8
Mercedes-Benz	E320	S210	06/97	08/02	6	3.2L	M112.941	PCQ = 12	41629		41969*	0.8
Mercedes-Benz	E320	W210	08/97	08/02	6	3.2L	M112.941	PCQ = 12	41629		41969*	0.8
Mercedes-Benz	E320	W211	08/02	2005	6	3.2L	M112.949	PCQ = 12	41629		41800	1.0
Mercedes-Benz	E430	W210	02/98	2002	8	4.3L	M113.940	PCQ = 16	41629		41800	1.0
Mercedes-Benz	E500	S211	2004	2006	8	5.0L	M113.967	PCQ = 16	41629		41800	1.0
Mercedes-Benz	E500	W211	08/02	09/06	8	5.0L	M113.967	PCQ = 16	41629		41800	1.0
Mercedes-Benz	E55 AMG	W210	03/98	2002	8	5.4L	M113.980	PCQ = 16	41629		41800	1.0
Mercedes-Benz	E55 AMG	W211	11/02	09/06	8	5.4L	M113.990	PCQ = 16	41629		41800	1.0
Mercedes-Benz	E63 AMG	AMG	05/96	1997	6	3.6L	W210		41629		41969*	0.8
Mercedes-Benz	ML320	W163	09/98	2003	6	3.2L	M112.942	PCQ = 12	41629		41800	1.0
Mercedes-Benz	ML350	W163	05/03	08/05	6	3.7L	M112.970	PCQ = 12	41629		41800	1.0
Mercedes-Benz	ML430	W163	04/99	2001	8	4.3L	M113.942	PCQ = 16	41629		41800	1.0
Mercedes-Benz	ML500	W163	10/01	08/05	8	5.0L	M113.965	PCQ = 16	41629		41800	1.0
Mercedes-Benz	ML55 AMG	W163	01/01	08/05	8	5.4L	M113.981	PCQ = 16	41629		41800	1.0
Mercedes-Benz	R500	W251	2006	2007	8	5.0L	M113.971	PCQ = 16			41966*	1.0
Mercedes-Benz	R500L	W251	2006	2007	8	5.0L	M113.971	PCQ = 16			41966*	1.0
Mercedes-Benz	S280	W140	10/95	1999	6	2.8L	M104		41602		41970*	0.8
Mercedes-Benz	S280		10/99	2005	6	2.8L	M112.922	PCQ = 12	41629		41800	1.0
Mercedes-Benz	S320	W140	09/93	04/99	6	3.2L	M104		41629		41969*	0.8
Mercedes-Benz	S320	W220	04/99	2002	6	3.2L	M112.944	PCQ = 12	41629		41800	1.1
Mercedes-Benz	S350	W220	03/03	02/06	6	3.7L	M112.972	PCQ = 12	41629		41800	1.0
Mercedes-Benz	S350L	W220	03/03	02/06	6	3.7L	M112.972	PCQ = 12	41629		41800	1.0
Mercedes-Benz	S420	W140	09/93	04/99	8	4.2L	M119		41629		41969*	0.8
Mercedes-Benz	S420L	W140	09/93	1997	8	4.2L	M119		41629		41969*	0.8
Mercedes-Benz	S430	W220	04/99	02/06	8	4.3L	M113.941	PCQ = 16	41629		41800	1.0
Mercedes-Benz	S430L	W220	04/99	02/06	8	4.3L	M113.941	PCQ = 16	41629		41800	1.0
Mercedes-Benz	S500L	W220	04/99	02/06	8	5.0L	M113.960	PCQ = 16	41629		41800	1.0
Mercedes-Benz	S600L	W220	2000	2003	12	5.8L	M137.970				41966*	1.0
Mercedes-Benz	S55K AMG	W140	07/93	1999	12	6.0L	M129		41629		41969*	0.8
Mercedes-Benz	S55K AMG	W220	11/00	02/03	12	6.0L	M137		41629		41800	1.0
Mercedes-Benz	S55K AMG	R230	09/02	05/08	8	5.4L	M113	Supercharged	41629		41800	1.0
Mercedes-Benz	S55K AMG	W220	03/03	02/06	8	5.5L	M113		41629		41800	1.0

MAKE	MODEL	SERIES / BADGE	FROM	TO	CYLS	CAPACITY	ENGINE	ADDITIONAL INFORMATION	REGULAR	PLATINUM (RAPIDFIRE®)	DOUBLE PLATINUM	GAP (MM)#
Mercedes-Benz	SL280	R129	11/95	1997	6	2.8L	M104		41602		41970*	0.8
Mercedes-Benz	SL280	R129	01/97	1999	6	2.8L	M104		41629		41800	1.1
Mercedes-Benz	SL320	R129	03/99	2002	6	3.2L	M112.943	PCQ = 12	41629		41800	1.1
Mercedes-Benz	SL350	R230	10/03	04/06	6	3.7L			41629		41800	1.0
Mercedes-Benz	SL500	R129	01/97	2000	8	5.0L	M119		41629		41969*	0.8
Mercedes-Benz	SL500	R129	03/00	2002	8	5.0L	M113		41629		41800	1.0
Mercedes-Benz	SL500	R230	07/02	04/06	8	5.0L	M113		41629		41800	1.0
Mercedes-Benz	SL600	R129	01/97	2003	12	6.0L	M120		41629		41800	1.1
Mercedes-Benz	SLK200	R170	2000	2004	4	2.0L	M111.958				41966*	1.0
Mercedes-Benz	SLK200K	R202	07/00	2004	4	2.0L	M111	Supercharged	41602	AC5	41801	1.0
Mercedes-Benz	SLK230K	R170	02/97	2000	4	2.3L	M111	Supercharged	41602	AC5	41801	1.0
Mercedes-Benz	SLK230K	R170	2000	2004	4	2.3L	M111.983				41966*	1.0
Mercedes-Benz	SLK230K	R202	07/00	2004	4	2.3L	M111	Supercharged	41602	AC5	41801	1.0
Mercedes-Benz	SLK320	R202	07/00	2004	6	3.2L	M112		41629		41800	1.0
Mercedes-Benz	SLK32K AMG	R170	2001	2004	6	3.2L	M112.960	PCQ = 12			41966*	1.0
Mercedes-Benz	SLK32K AMG	R202	09/01	2004	6	3.2L	M112	Supercharged	41602	AC5	41801	1.0
Mercedes-Benz	SLK55 AMG	R171	2005	2011	8	5.4L	M113.989	PCQ = 16			41966*	1.0
Mercedes-Benz	VIANO	639	2005	2006	6	3.2L	M112.951	PCQ = 12			41966*	1.0
Mercedes-Benz	VIANO	639	2005	2010	6	3.7L	M112.976	PCQ = 12			41966*	1.0
Mercedes-Benz	Vito	113	02/98	03/04	4	2.0L	M111		41602	AC5	41970*	0.9
Mercedes-Benz	VITO	119P	2004	2006	6	3.2L	M112.951	PCQ = 12			41966*	1.0
MG												
MG	MGB		1963	1981	4	1.8L			R42XLS	AC4	41804	0.8
MG	MGF		08/02	2005	4	1.8L	18K4		41629		41800	1.1
MG	Midget		1967	1979	4	1.3L	1275		R42XLS	AC4	41804	0.8
MG	Rover	75	03/01	2005	6	2.5L	25K4FM		41602	AC5	41801	1.0
MG	ZT		05/02	2005	6	2.5L	25K4F		41602	AC5	41801	1.1
MINI												
Mini	Cooper	R50	03/02	02/07	4	1.6L	W10B16AB				41800	1.1
Mini	Cooper S	R53	03/02	02/07	4	1.6L	W11B16AA				41800	1.1
MITSUBISHI												
Mitsubishi	380		10/05	2008	6	3.8L	6G75	SOHC	41629		41800	1.1
Mitsubishi	3000GT		10/92	1998	6	3.0L	6G72A	DOHC	41602	AC5	41801	1.1
Mitsubishi	ASX	XA	2010	on	4	2.0L	4B11		41629		41969*	0.8
Mitsubishi	Canter	T217	1975	1979	4	2.4L	4G53		R42XLS	AC4	41804	0.8
Mitsubishi	Canter	FC211	07/79	1980	4	2.4L	4G53		R42XLS	AC4	41804	0.8
Mitsubishi	Canter	FC212	02/81	1986	4	2.6L	4G54		R43XLS	AC4		0.8
Mitsubishi	Canter	FC432	04/86	1992	4	2.6L	4G54		R42XLS	AC4	41804	0.8
Mitsubishi	Challenger		03/98	2006	6	3.0L	6G72		41602	AC5	41801	1.1
Mitsubishi	Chrysler Galant	GA	1971	1972	4	1.3L	4G30		42XLS			0.8
Mitsubishi	Chrysler Galant	GA	1971	1972	4	1.5L	4G31		42XLS			0.8
Mitsubishi	Chrysler Galant	GB	1972	1974	4	1.5L	4G33		42XLS			0.8
Mitsubishi	Chrysler Galant	GB	1972	1974	4	1.6L	4G32		42XLS			0.8
Mitsubishi	Chrysler Galant	GC	1974	1976	4	1.6L	4G32		42XLS			0.8
Mitsubishi	Chrysler Galant	GD	1976	1977	4	1.6L	4G32		43XLS	AC4		0.8
Mitsubishi	Colt	RA	01/81	10/82	4	1.4L			43XLS	AC4		0.8
Mitsubishi	Colt	RB	10/82	03/84	4	1.4L	4G33		43XLS	AC4		0.8
Mitsubishi	Colt	RB	10/82	03/84	4	1.6L	4G32		43XLS	AC4		0.8

MAKE	MODEL	SERIES / BADGE	FROM	TO	CYLS	CAPACITY	ENGINE	ADDITIONAL INFORMATION	REGULAR	PLATINUM (RAPIDFIRE®)	DOUBLE PLATINUM	GAP (MM)#
Mitsubishi	Colt	RC	10/83	09/96	4	1.4L	4G33		R42XLS	AC4	41804	0.8
Mitsubishi	Colt	RC	10/83	09/96	4	1.6L	4G32		R42XLS	AC4	41804	0.8
Mitsubishi	Colt	RD	10/86	08/88	4	1.4L	4G33		R42XLS	AC4	41804	0.8
Mitsubishi	Colt	RD	10/86	08/88	4	1.6L	4G32		R42XLS	AC4	41804	0.8
Mitsubishi	Colt	RE	09/88	06/90	4	1.4L	4G33		R42XLS	AC4	41804	0.8
Mitsubishi	Colt	RE	09/88	06/90	4	1.6L	4G32		R42XLS	AC4	41804	0.8
Mitsubishi	Cordia	AA	04/83	10/84	4	1.6L	4G32		43XLS	AC4		0.8
Mitsubishi	Cordia	AA	05/84	10/84	4	1.8L	4G62BT	Turbo	R42XLS	AC4	41804	1.1
Mitsubishi	Cordia	AB	11/84	11/85	4	1.8L	4G37		R42XLS	AC4	41804	1.1
Mitsubishi	Cordia	AB	11/84	11/85	4	1.8L	4G62BT	Turbo	R42XLS	AC4	41804	1.1
Mitsubishi	Cordia	AC	12/85	07/89	4	1.8L	4G37		R42XLS	AC4	41804	1.1
Mitsubishi	Cordia	AC	12/85	07/89	4	1.8L	4G62BT	Turbo	R42XLS	AC4	41804	1.1
Mitsubishi	Delica		1994	2006	6	3.0L	6G72				41966*	1.1
Mitsubishi	Express	SF	1986	1990	4	2.0L	4G63		R43XLS	AC4		0.8
Mitsubishi	Express	SF	08/86	05/90	4	2.4L	4G64		R43XLS	AC4		0.8
Mitsubishi	Express	SG	1990	1991	4	2.0L	4G63		R42XLS	AC4	41804	0.8
Mitsubishi	Express	SG	1990	1991	4	2.4L	4G64		R42XLS	AC4	41804	1.1
Mitsubishi	Express	SH	1991	1994	4	2.0L	4G63		R42XLS	AC4	41804	0.8
Mitsubishi	Express	SH	1991	1994	4	2.4L	4G64		R42XLS	AC4	41804	1.1
Mitsubishi	Express	SJ	1994	2006	4	2.0L	4G63		41629		41800	1.1
Mitsubishi	Express	SJ	1994	2003	4	2.4L	4G64		41629		41800	1.1
Mitsubishi	Express	WA	1994	2005	4	2.4L	4G64		41602	AC5	41801	1.1
Mitsubishi	Galant	HG	1988	1990	4	2.0L	4G63		R42XLS	AC4	41804	1.1
Mitsubishi	Galant	HH	1990	1993	4	2.0L	4G63		R42XLS	AC4	41804	1.1
Mitsubishi	Galant	HJ	04/93	1995	4	2.0L	4G63A	16V	FR3LS		41800	1.1
Mitsubishi	Galant	HJ	04/93	1996	6	2.0L	6A12A	24V	41602	AC5	41801	1.1
Mitsubishi	L200		1980	1984	4	1.6L	4G32		43XLS	AC4		0.8
Mitsubishi	L200		1980	1985	4	2.0L	4G52		42XLS			0.8
Mitsubishi	L200	MA	06/81	09/81	4	2.0L	4G52		42XLS			0.8
Mitsubishi	L200	MB	10/81	09/82	4	2.0L	4G52		42XLS			0.8
Mitsubishi	L300 Express	SA	1980	1982	4	1.6L	4G32		R43XLS	AC4		0.8
Mitsubishi	L300 Express	SB	1981	1983	4	1.6L	4G32		R43XLS	AC4		0.8
Mitsubishi	L300 Express	SB	1982	1983	4	1.8L	4G62		R43XLS	AC4		0.8
Mitsubishi	L300 Express	SC	1983	1984	4	1.6L	4G32		R43XLS	AC4		0.8
Mitsubishi	L300 Express	SC	1983	1984	4	1.8L	4G62		R43XLS	AC4		0.8
Mitsubishi	L300 Express	SD	1984	1985	4	1.6L	4G32		R43XLS	AC4		0.8
Mitsubishi	L300 Express	SD	1984	1985	4	1.8L	4G62		R43XLS	AC4		0.8
Mitsubishi	L300 Express	SD	1984	1985	4	2.0L	4G63		R43XLS	AC4		0.8
Mitsubishi	L300 Express	SE	1985	1986	4	1.6L	4G32		R43XLS	AC4		0.8
Mitsubishi	L300 Express	SE	1985	1986	4	2.0L	4G63		R43XLS	AC4		0.8
Mitsubishi	Lancer	LA	09/74	1976	4	1.4L	4G33		R43XLS	AC4		0.8
Mitsubishi	Lancer	LB	1977	1979	4	1.4L	4G33		43XLS	AC4		0.8
Mitsubishi	Lancer	LB	04/77	1981	4	1.6L	4G32		R42XLS	AC4	41804	0.8
Mitsubishi	Lancer	LC	04/77	1979	4	1.6L	4G32		R42XLS	AC4	41804	0.8
Mitsubishi	Lancer	CA	06/88	05/90	4	1.5L	4G15	MPI	R42XLS	AC4	41804	1.1
Mitsubishi	Lancer	CA	06/88	05/90	4	1.5L	4G15	CARB		AC4		0.8
Mitsubishi	Lancer	CB	1990	1992	4	1.5L	4G15	CARB		AC4		0.8
Mitsubishi	Lancer	CB	06/90	06/92	4	1.5L	4G15	MPI	R42XLS	AC4	41804	1.1

MAKE	MODEL	SERIES / BADGE	FROM	TO	CYLS	CAPACITY	ENGINE	ADDITIONAL INFORMATION	REGULAR	PLATINUM (RAPIDFIRE®)	DOUBLE PLATINUM	GAP (MM)#
Mitsubishi	Lancer	CB	06/90	06/92	4	1.6L	4G61	MPI	R42XLS	AC4	41804	1.1
Mitsubishi	Lancer	CC	1992	1996	4	1.5L	4G15	CARB	43XLS	AC4		0.8
Mitsubishi	Lancer	CC	1992	1996	4	1.8L	4G93T	Turbo DOHC MPI	41602		41970*	0.8
Mitsubishi	Lancer	CC	06/92	04/96	4	1.6L	4G92	SOHC MPI	FR3LS		41800	1.1
Mitsubishi	Lancer	CC	06/92	04/96	4	1.8L	4G93	SOHC MPI	FR3LS		41800	1.1
Mitsubishi	Lancer	CC	09/92	1996	4	1.8L	4G93	DOHC MPI	41629		41969*	0.8
Mitsubishi	Lancer	CE	07/96	1998	4	1.8L	4G93		FR3LS		41800	1.1
Mitsubishi	Lancer	CE	09/96	01/03	4	1.5L	4G15	MPI	43XLS	AC4		0.8
Mitsubishi	Lancer	CEII	1998	2003	4	1.8L	4G93		41629		41800	1.1
Mitsubishi	Lancer	EVO VI	2001	2001	4	2.0L	4G63T	Turbo	41629		41800	1.1
Mitsubishi	Lancer	EVO VII	2002	2003	4	2.0L	4G63T	Turbo	41629		41800	1.1
Mitsubishi	Lancer	CG	06/02	11/05	4	2.0L	4G94		41629		41800	1.1
Mitsubishi	Lancer	CH	06/02	11/05	4	2.0L	4G94		41629		41800	1.1
Mitsubishi	Lancer	EVO VIII	2004	2004	4	2.0L	4G63T	Turbo	41629		41800	1.1
Mitsubishi	Lancer	CJ MIVEC	10/07	on	4	2.0L	4B11		41629		41969*	0.8
Mitsubishi	Lancer	CJ/CF	2012	2016	4	2.0L	4B11				41966*	1.1
Mitsubishi	Lancer	CJ VRX	2008	on	4	2.4L	4B12		41629		41969*	0.8
Mitsubishi	Magna	TM	1985	1987	4	2.6L	4G54	Leaded	43XLS	AC4		0.8
Mitsubishi	Magna	TM	1986	1987	4	2.6L	4G54	Unleaded	R42XLS	AC4	41804	0.8
Mitsubishi	Magna	TN	1986	1989	4	2.6L	4G54		R42XLS	AC4	41804	0.8
Mitsubishi	Magna	TP	1989	1992	4	2.6L	4G54		R42XLS	AC4	41804	0.8
Mitsubishi	Magna	TR	1991	1994	4	2.6L	4G54		R42XLS	AC4	41804	0.8
Mitsubishi	Magna	TR	1991	1994	6	3.0L	6G72		R42XLS	AC4	41804	1.1
Mitsubishi	Magna	TS	1994	1996	4	2.6L	4G54		R42XLS	AC4	41804	0.8
Mitsubishi	Magna	TS	1994	1996	6	3.0L	6G72		R42XLS	AC4	41804	1.1
Mitsubishi	Magna	TE	1996	1997	4	2.4L	4G64		FR3LS		41800	1.1
Mitsubishi	Magna	TE	1996	1997	6	3.0L	6G72	3 Front Bank	41602	AC5	41801	1.1
Mitsubishi	Magna	TE	1996	1997	6	3.0L	6G72	3 Rear Bank			41801	1.1
Mitsubishi	Magna	TF	1997	1999	4	2.4L	4G64		FR3LS		41800	1.1
Mitsubishi	Magna	TF	1997	1999	6	3.0L	6G72	3 Front Bank	41602	AC5	41801	1.1
Mitsubishi	Magna	TF	1997	1999	6	3.0L	6G72	3 Rear Bank			41801	1.1
Mitsubishi	Magna	TH	1999	2000	6	3.0L	6G72	3 Front Bank	41602	AC5	41801	1.1
Mitsubishi	Magna	TH	1999	2000	6	3.0L	6G72	3 Rear Bank			41801	1.1
Mitsubishi	Magna	TH	1999	2000	6	3.5L	6G74	3 * Front Bank	FR3LS		41800	1.1
Mitsubishi	Magna	TH	1999	2000	6	3.5L	6G74	3 * Rear Bank			41800	1.1
Mitsubishi	Magna	TJ	2000	2003	6	3.0L	6G72	3 Front Bank	41602	AC5	41801	1.1
Mitsubishi	Magna	TJ	2000	2003	6	3.0L	6G72	3 Rear Bank			41801	1.1
Mitsubishi	Magna	TJ	07/00	05/03	6	3.5L	6G74	3 * Front Bank	FR3LS		41800	1.1
Mitsubishi	Magna	TJ	07/00	05/03	6	3.5L	6G74	3 * Rear Bank			41800	1.1
Mitsubishi	Magna	TJ Ralliart	02/02	05/03	6	3.5L	6G74	3 * Front Bank	41602	AC5	41801	1.1
Mitsubishi	Magna	TJ Ralliart	02/02	05/03	6	3.5L	6G74	3 * Rear Bank			41801	1.1
Mitsubishi	Magna	TL	06/03	10/04	6	3.5L	6G74	3 * Front Bank	41629		41800	1.1
Mitsubishi	Magna	TL	06/03	10/04	6	3.5L	6G74	3 * Rear Bank			41800	1.1
Mitsubishi	Magna	TW	2004	2005	6	3.5L	6G74	3 * Front Bank	41629		41800	1.1
Mitsubishi	Magna	TW	2004	2005	6	3.5L	6G74	3 * Rear Bank			41800	1.1
Mitsubishi	Miroge	CE	1996	09/04	4	1.5L		MPI		AC4		1.1
Mitsubishi	Nimbus	UC	09/87	1992	4	2.0L	4G63		R42XLS	AC4	41804	1.1
Mitsubishi	Nimbus	UF	1992	1998	4	2.4L	4G64	16V	FR3LS		41800	1.1

MAKE	MODEL	SERIES / BADGE	FROM	TO	CYLS	CAPACITY	ENGINE	ADDITIONAL INFORMATION	REGULAR	PLATINUM (RAPIDFIRE®)	DOUBLE PLATINUM	GAP (MM)#
Mitsubishi	Nimbus	UF	02/92	08/92	4	2.4L	4G64	8V	R42XLS	AC4	41804	1.1
Mitsubishi	Nimbus	UG	1998	2003	4	2.4L	4G64	16V	FR3LS		41800	1.1
Mitsubishi	Outlander	ZE	01/03	2004	4	2.4L	4G64		41629		41800	1.1
Mitsubishi	Outlander	ZG	2006	2009	4	2.4L	4B12				41969*	0.8
Mitsubishi	Outlander	ZH	2009	10/12	4	2.4L	4B12				41969*	0.8
Mitsubishi	Outlander	ZJ	11/12	On	4	2.0L	4J11				41968*	1.1
Mitsubishi	Outlander	ZJ	11/12	On	4	2.4L	4J12				41968*	1.1
Mitsubishi	Outlander	ZK	11/12	On	4	2.0L	4J11				41968*	1.1
Mitsubishi	Outlander	Zk	11/12	On	4	2.4L	4J12				41968*	1.1
Mitsubishi	Pajero	NA	1983	1984	4	2.6L	4G54		R43XLS	AC4		0.8
Mitsubishi	Pajero	NB	1984	1985	4	2.6L	4G54		R43XLS	AC4		0.8
Mitsubishi	Pajero	NC	1985	1986	4	2.6L	4G54		R43XLS	AC4		0.8
Mitsubishi	Pajero	ND	1986	1987	4	2.6L	4G54		R42XLS	AC4	41804	0.8
Mitsubishi	Pajero	NE	1987	1988	4	2.6L	4G54		R42XLS	AC4	41804	0.8
Mitsubishi	Pajero	NF	1988	1989	4	2.6L	4G54		R43XLS	AC4		0.8
Mitsubishi	Pajero	NF	1988	1989	6	3.0L	6G72		R43XLS	AC4	41802	1.1
Mitsubishi	Pajero	NG	1989	1990	4	2.6L	4G54		R43XLS	AC4		0.8
Mitsubishi	Pajero	NG	1989	1990	6	3.0L	6G72		R43XLS	AC4	41802	1.1
Mitsubishi	Pajero	NH	1991	1993	4	2.6L	4G54		R43XLS	AC4		0.8
Mitsubishi	Pajero	NH	1991	1993	6	3.0L	6G72		R43XLS	AC4	41802	1.1
Mitsubishi	Pajero	NK	1991	1997	6	3.0L	6G72		R43XLS	AC4	41802	1.1
Mitsubishi	Pajero	NJ	1993	1996	6	3.0L	6G72		R43XLS	AC4	41802	1.1
Mitsubishi	Pajero	NJ	1993	1996	6	3.5L	6G74		41629		41800	1.1
Mitsubishi	Pajero	NK	1993	1999	6	3.5L	6G74		41629		41800	1.1
Mitsubishi	Pajero	NL	1997	2000	6	3.5L	6G74		41629		41800	1.1
Mitsubishi	Pajero	NM	2000	2004	6	3.5L	6G74		41629		41800	1.1
Mitsubishi	Pajero	NP	11/02	05/04	6	3.5L	6G74A		41629		41800	1.1
Mitsubishi	Pajero	NP	10/03	11/06	6	3.8L	6G75		41602	AC5	41801	1.1
Mitsubishi	Pajero	NS	11/06	2009	6	3.8L	6G76		41602		41970*	0.8
Mitsubishi	Pajero	NT	2009	on	6	3.8L	6G77		41602		41970*	0.8
Mitsubishi	Pajero iO	QA	01/99	08/01	4	1.6L	4G18		41629		41800	1.1
Mitsubishi	Pajero iO	QA	01/99	08/01	4	1.8L	4G93		41629		41800	1.1
Mitsubishi	Scorpion	GE	03/78	1979	4	2.0L	4G52		R42XLS	AC4	41804	0.8
Mitsubishi	Sigma	GE	1977	1980	4	1.6L	4G32		R43XLS	AC4		0.8
Mitsubishi	Sigma	GE	1977	1980	4	2.0L	4G52		R42XLS	AC4	41804	0.8
Mitsubishi	Sigma	GE	10/78	1980	4	1.85L	4G51		R43XLS	AC4		0.8
Mitsubishi	Sigma	Scorpion	1979	1982	4	2.6L			43XLS	AC4		0.8
Mitsubishi	Sigma	GH	1980	1982	4	1.6L	4G32		R43XLS	AC4		0.8
Mitsubishi	Sigma	GH	1980	1982	4	2.0L	4G52		R42XLS	AC4	41804	0.8
Mitsubishi	Sigma	GJ	1982	1984	4	1.6L	4G32		R43XLS	AC4		0.8
Mitsubishi	Sigma	GJ	1982	1984	4	2.0L	4G52		R42XLS	AC4	41804	0.8
Mitsubishi	Sigma	GK	1984	1985	4	1.6L	4G32		R43XLS	AC4		0.8
Mitsubishi	Sigma	GK	1984	1985	4	2.0L	4G52		R42XLS	AC4	41804	0.8
Mitsubishi	Sigma	GN	1985	1985	4	2.0L	4G52		R42XLS	AC4	41804	0.8
Mitsubishi	Sigma	GN	1985	1987	4	2.6L	4G54		R43XLS	AC4		0.8
Mitsubishi	Starwagon	SF	1986	1990	4	2.0L	4G63		R43XLS	AC4		0.8
Mitsubishi	Starwagon	SF	08/86	05/90	4	2.4L	4G64		R42XLS	AC4	41804	0.8
Mitsubishi	Starwagon	SG	1990	1991	4	2.0L	4G63		R42XLS	AC4	41804	0.8

MAKE	MODEL	SERIES / BADGE	FROM	TO	CYLS	CAPACITY	ENGINE	ADDITIONAL INFORMATION	REGULAR	PLATINUM (RAPIDFIRE®)	DOUBLE PLATINUM	GAP (MM)#
Mitsubishi	Starwagon	SG	1990	1991	4	2.4L	4G64		R42XLS	AC4	41804	1.1
Mitsubishi	Starwagon	SH	1991	1994	4	2.0L	4G63		R42XLS	AC4	41804	0.8
Mitsubishi	Starwagon	SH	1991	1994	4	2.4L	4G64		R42XLS	AC4	41804	1.1
Mitsubishi	Starwagon	SJ	1994	2001	4	2.0L	4G63		41629		41800	1.1
Mitsubishi	Starwagon	WA	1994	2003	4	2.4L	4G64		41602	AC5	41801	1.1
Mitsubishi	Starwagon	WA	1995	10/03	4	2.0L	4G63		41629		41800	1.1
Mitsubishi	Starwagon	WA	1995	09/03	4	2.4L	4G64		41629		41800	1.1
Mitsubishi	Starwagon	WA	1995	07/96	6	3.0L	6G72		41602	AC5	41801	1.1
Mitsubishi	Triton	ME	1986	1988	4	2.6L	4G54		R42XLS	AC4	41804	0.8
Mitsubishi	Triton	MF	1988	1990	4	2.6L	4G54		R42XLS	AC4	41804	0.8
Mitsubishi	Triton	MG	1989	1990	4	2.6L	4G54		R42XLS	AC4	41804	0.8
Mitsubishi	Triton	MH 2600	1990	1992	4	2.6L			43XLS	AC4		0.8
Mitsubishi	Triton	MH 3000	1990	1992	6	3.0L				AC4		1.1
Mitsubishi	Triton	MJ 2600	1993	1996	4	2.6L	4G5		43XLS	AC4		0.8
Mitsubishi	Triton	MJ 3000	1993	1996	6	3.0L	6G7			AC4		1.1
Mitsubishi	Triton	MK	10/96	2006	4	2.4L	4G64				41800	1.1
Mitsubishi	Triton	MK	10/96	2006	6	3.0L	6G72		41602	AC5	41801	1.1
Mitsubishi	Triton	ML	06/06	2009	4	2.4L	4G64				41800	1.1
Mitsubishi	Triton	ML	06/06	2009	6	3.5L	6G74		41629		41800	1.1
Mitsubishi	Triton	MN	2009	on	4	2.4L	4G64				41800	1.1
Mitsubishi	Triton	MQ	09/15	on	4	2.4L	4G64				41800	1.1
Mitsubishi	Verada	KR	1991	1994	6	3.0L	6G72		R42XLS	AC4	41804	1.1
Mitsubishi	Verada	KS	1994	1996	6	3.0L	6G72		R42XLS	AC4	41804	1.1
Mitsubishi	Verada	KE	1996	1997	6	3.5L	6G74	Front Bank	FR3LS		41800	1.1
Mitsubishi	Verada	KE	1996	1997	6	3.5L	6G74	Rear Bank			41800	1.1
Mitsubishi	Verada	KF	1997	1999	6	3.5L	6G74	Front Bank	FR3LS		41800	1.1
Mitsubishi	Verada	KF	1997	1999	6	3.5L	6G74	Rear Bank			41800	1.1
Mitsubishi	Verada	KH	1999	2000	6	3.5L	6G74	Front Bank	FR3LS		41800	1.1
Mitsubishi	Verada	KH	1999	2000	6	3.5L	6G74	Rear Bank			41800	1.1
Mitsubishi	Verada	KJ	2000	2003	6	3.5L	6G74	Front Bank	FR3LS		41800	1.1
Mitsubishi	Verada	KJ	2000	2003	6	3.5L	6G74	Rear Bank			41800	1.1
Mitsubishi	Verada	KL	06/03	10/04	6	3.5L	6G74	Front Bank	41629		41800	1.1
Mitsubishi	Verada	KL	06/03	10/04	6	3.5L	6G74	Rear Bank			41800	1.1
Mitsubishi	Verada	KW	10/04	07/05	6	3.5L	6G74	Front Bank	41629		41800	1.1
Mitsubishi	Verada	KW	10/04	07/05	6	3.5L	6G74	Rear Bank			41800	1.1
NISSAN												
Nissan	720		1979	1986	4	1.8L	L18		R43XLS	AC4		0.8
Nissan	1200	B110	06/70	1974	4	1.2L	A12		R43XLS	AC4		0.8
Nissan	1200	B120	06/70	1985	4	1.2L	A12		R43XLS	AC4		0.8
Nissan	1600	510	1968	1972	4	1.6L	L16		R42XLS	AC4	41804	0.8
Nissan	120Y	B210	1974	1979	4	1.2L	A12		R43XLS	AC4		0.8
Nissan	180B	610	1972	1977	4	1.8L	L18		R42XLS	AC4	41804	0.8
Nissan	180SX	S13	01/91	12/98	4	2.0L	SR20DET	Turbo	41602	AC5	41970*	0.9
Nissan	200B	810	1977	1982	4	2.0L	L20B		R42XLS	AC4	41804	0.8
Nissan	200SX	S14	10/94	2000	4	2.0L	SR20DET	Turbo	41602	AC5	41970*	0.9
Nissan	200SX	S15	11/00	2004	4	2.0L	SR20DET	Turbo	41602	AC5	41970*	0.9
Nissan	240C		1971	1972	6	2.4L	L24		R42XLS	AC4	41804	0.8
Nissan	240K		1975	1978	6	2.4L	L24		R42XLS	AC4	41804	0.8

MAKE	MODEL	SERIES / BADGE	FROM	TO	CYLS	CAPACITY	ENGINE	ADDITIONAL INFORMATION	REGULAR	PLATINUM (RAPIDFIRE®)	DOUBLE PLATINUM	GAP (MM)#
Nissan	240Z		1970	1974	6	2.4L	L24		R42XLS	AC4	41804	0.8
Nissan	260C		1972	1978	6	2.6L	L26		R42XLS	AC4	41804	0.8
Nissan	260Z		1974	1978	6	2.6L	L26		R42XLS	AC4	41804	0.8
Nissan	280C		1977	1979	6	2.8L	L28S		R42XLS	AC4	41804	0.8
Nissan	280C		01/82	1984	6	2.8L	L28		R42XLS	AC4	41804	1.1
Nissan	280ZX		1978	1984	6	2.8L	L28E		R42XLS	AC4	41804	0.8
Nissan	280ZX		1982	1984	6	2.8L	L28		R42XLS	AC4	41804	1.1
Nissan	300C		05/84	1988	6	3.0L	VG30E	PCQ = 6			41825	1.1
Nissan	300ZX	Z31	05/84	12/89	6	3.0L	VG30E				41825	1.1
Nissan	300ZX	Z31	01/86	12/89	6	3.0L	VG30ET	Turbo			41825	1.1
Nissan	300ZX	Z32	12/89	1997	6	3.0L	VG30DE		41629		41800	1.1
Nissan	350Z	Z33	2002	03/07	6	3.5L	VQ35DE				41835*	1.1
Nissan	350Z	Z33	04/07	04/09	6	3.5L	VQ35HR	Convertible			41964*	1.1
Nissan	350Z	Z33	04/07	04/09	6	3.5L	VQ35HR	Coupe			41964*	1.1
Nissan	Almera	N17	08/12	on	4	1.5L	HR15DE				41964*	1.1
Nissan	Altima	L33	2013	2018	6	3.5L	VQ35DE				41964*	1.1
Nissan	Bluebird	Series I, II	05/81	1985	4	2.0L	L20B		R42XLS	AC4	41804	1.1
Nissan	Bluebird	Series III	04/85	1986	4	2.0L	CA20S	PCQ = 8			41825	1.1
Nissan	Bluebird	U13	10/93	1997	4	2.4L	KA24DE		41629		41800	1.1
Nissan	Cabstar	F22	05/82	1987	4	2.0L	Z20		R42XLS	AC4	41804	0.8
Nissan	Cabstar	H40	05/82	1987	4	2.2L	Z22		R43XLS	AC4		0.8
Nissan	Dualis	J10	2007	2008	4	2.0L	MR20DE				41964*	1.1
Nissan	Dualis	J10 - ST, Ti	12/07	on	4	2.0L	MR20DE				41964*	1.1
Nissan	Dualis	J10 Ser 2	04/10	04/12	4	2.0L	MR20DE				41964*	1.1
Nissan	Dualis	J10 Ser 3	05/12	on	4	2.0L	MR20DE				41964*	1.1
Nissan	Dualis +2	J10 Ser 2	07/10	04/12	4	2.0L	MR20DE				41964*	1.1
Nissan	Dualis +2	J10 Ser 3	05/12	on	4	2.0L	MR20DE				41964*	1.1
Nissan	Elgrand	E52	2010	2018	6	3.5L	VQ35DE				41964*	1.1
Nissan	Gazelle	S12	01/84	1988	4	2.0L	CA20E	PCQ = 8			41825	1.1
Nissan	Homer	T20	04/76	1981	4	2.0L	H20		R43XLS	AC4		0.8
Nissan	Infiniti Q45	NG50	09/93	1997	8	4.5L	VH45DE		41629		41800	1.1
Nissan	Juke	F15	02/12	on	4	1.6L	HR16DE	DOHC VVT			41964*	1.1
Nissan	Juke	F15	10/13	on	4	1.6L	MR16DDT	Direct Injection I/C Turbo			41964*	0.9
Nissan	Maxima	HJ30	05/90	1995	6	3.0L	VG30E		41629		41800	1.1
Nissan	Maxima	A32	02/95	1999	6	3.0L	VQ30DE		FR3LS		41800	1.1
Nissan	Maxima	A33	1999	2003	6	3.0L	VQ30DE		FR3LS		41800	1.1
Nissan	Maxima	BBUJ31	12/03	03/09	6	3.5L	VQ35DE	170kW			41835*	1.1
Nissan	Maxima	J32 - 350	04/09	on	6	3.5L	VQ35DE				41964*	1.1
Nissan	Micra	AK11E	06/95	1998	4	1.3L	CG13DE		FR3LS		41800	1.1
Nissan	Micra	K12	2004	09/10	4	1.4L	CR14DE				41835*	1.1
Nissan	Micra	K13	10/10	on	4	1.2L	HR12DE				41964*	1.1
Nissan	Micra	K13	10/10	on	4	1.5L	HR15DE				41964*	1.1
Nissan	Murano	Z50	2005	2008	6	3.5L	VQ35DE	172kW			41835*	1.1
Nissan	Murano	Z51 - ST, Ti	01/09	2014	6	3.5L	VQ35DE				41964*	1.1
Nissan	Navara	D21	01/86	1995	4	2.0L	Z20		R42XLS	AC4	41804	0.8
Nissan	Navara	D21	01/86	1987	4	2.4L	Z24		R43XLS	AC4		0.8
Nissan	Navara	D21	09/87	1996	4	2.4L	Z24	Exhaust CARB	R43XLS	AC4		0.8

MAKE	MODEL	SERIES / BADGE	FROM	TO	CYLS	CAPACITY	ENGINE	ADDITIONAL INFORMATION	REGULAR	PLATINUM (RAPIDFIRE®)	DOUBLE PLATINUM	GAP (MM)#
Nissan	Navara	D21	09/87	1996	4	2.4L	Z24	Inlet CARB	R42XLS	AC4	41804	0.8
Nissan	Navara	D21	06/92	1997	4	2.4L	KA24E	EFI			41806	1.1
Nissan	Navara	D21	06/92	1997	6	3.0L	VG30		41602	AC5	41801	1.1
Nissan	Navara	D22	03/97	1999	4	2.4L	KA24E	SOHC			41806	1.1
Nissan	Navara	D22	07/99	12/05	4	2.4L	KA24DE	DOHC	41629		41800	1.1
Nissan	Navara	D22	06/00	2005	6	3.0L	VG30E	EFI	41629		41800	1.1
Nissan	Navara	D22	03/03	2005	6	3.3L	VG33E		41629		41800	1.1
Nissan	Navara	D40	2005	on	6	4.0L	VG40DE				41835*	1.1
Nissan	Nomad	GC22	12/86	1988	4	2.4L	Z24		R42XLS	AC4	41804	0.8
Nissan	Nomad	GC22	04/88	1992	4	2.4L	Z24	Exhaust	R43XLS	AC4		0.8
Nissan	Nomad	GC22	04/88	1992	4	2.4L	Z24	Inlet	R42XLS	AC4	41804	0.8
Nissan	Note	E11	2008	2012	4	1.6L	HR16DE				41964*	1.1
Nissan	NX	AB13	10/91	1996	4	2.0L	SR20DE		41602	AC5	41801	1.1
Nissan	Pathfinder	WD21	08/86	07/92	4	2.4L	Z24S	Exhaust	43XLS	AC4		0.8
Nissan	Pathfinder	WD21	12/86	1992	4	2.4L	Z24	Inlet	R42XLS	AC4	41804	0.8
Nissan	Pathfinder	HYD21	09/92	1995	6	3.0L	VG30E	EFI	41602	AC5	41970*	0.9
Nissan	Pathfinder	R50	11/95	1999	6	3.3L	VG33E		FR3LS		41800	1.1
Nissan	Pathfinder	R50 Ser II	02/99	2005	6	3.3L	VG33E		FR3LS		41800	1.0
Nissan	Pathfinder	R51	2005	2010	6	4.0L	VG40DE				41835*	1.1
Nissan	Pathfinder	R52	2013	2018	6	3.5L	VG35DE				41964*	1.1
Nissan	Patrol	G61	1965	1980	6	4.0L	P40		R43XLS	AC4		0.8
Nissan	Patrol	MQ	06/80	1985	6	4.0L	P40		R43XLS	AC4		0.8
Nissan	Patrol	MQ	09/80	1987	6	2.8L	L28		R42XLS	AC4	41804	0.8
Nissan	Patrol	GQ	02/88	1999	6	4.2L	TB42S		R43XLS	AC4		0.8
Nissan	Patrol	GQ	03/90	1997	6	3.0L	RB30				41969*	0.9
Nissan	Patrol	GQ	02/92	1997	6	4.2L	TB42E	EFI	R43XLS	AC4	41802	0.9
Nissan	Patrol	GU	12/97	2001	6	4.5L	TB45E		R43XLS	AC4	41802	1.1
Nissan	Patrol	GUIII	2001	2004	6	4.8L	TB48DE				41835*	1.1
Nissan	Patrol	GUIV	2005	01/12	6	4.8L	TB48DE				41835*	1.1
Nissan	Patrol	Y62	2013	2018	8	5.6L	VK56VD				41964*	1.1
Nissan	Pick-up	521	1965	1979	4	1.3L	J13	Ute	R43XLS	AC4		0.8
Nissan	Pintara	R31	09/86	1990	4	2.0L	CA20E	PCQ = 8			41825	1.1
Nissan	Pintara	UA	11/89	1993	4	2.4L	KA24E				41806	1.1
Nissan	Prairie	1.5L	1982	1986	4	1.5L	E15		43XLS	AC4		0.8
Nissan	Pulsar	N10	1980	1981	4	1.4L	A14		R43XLS	AC4		0.8
Nissan	Pulsar	N10	1981	1982	4	1.3L	E13		R43XLS	AC4		0.8
Nissan	Pulsar	N10	1981	1983	4	1.5L	E15S		R43XLS	AC4		0.8
Nissan	Pulsar	N12	1982	1987	4	1.5L	E15S		R43XLS	AC4		0.8
Nissan	Pulsar	N12	1983	1986	4	1.3L	E13		R43XLS	AC4		0.8
Nissan	Pulsar	N12	10/83	1985	4	1.5L	E15ET	Turbo	R42XLS	AC4	41804	0.8
Nissan	Pulsar	N12	01/86	1987	4	1.5L	E15ET	Turbo	R42XLS	AC4	41804	1.1
Nissan	Pulsar	N12	04/86	1987	4	1.6L	E16		R43XLS	AC4	41802	1.1
Nissan	Pulsar	N13	02/87	1991	4	1.8L	CA18DE		41602	AC5	41801	1.1
Nissan	Pulsar	N13	07/87	09/91	4	1.6L	16LF		R42XLS	AC4	41804	1.1
Nissan	Pulsar	N13	07/87	09/91	4	1.8L	18LE		R42XLS	AC4	41804	1.1
Nissan	Pulsar	N14 GTR	08/90	07/92	4	2.0L	SR20DET	Turbo	41602	AC5	41801	1.1
Nissan	Pulsar	N14	10/91	1995	4	1.6L	GA16DE		FR3LS		41800	1.1
Nissan	Pulsar	N14	11/91	09/95	4	2.0L	SR20DE		41629		41800	1.1

MAKE	MODEL	SERIES / BADGE	FROM	TO	CYLS	CAPACITY	ENGINE	ADDITIONAL INFORMATION	REGULAR	PLATINUM (RAPIDFIRE®)	DOUBLE PLATINUM	GAP (MM)#
Nissan	Pulsar	N15	1995	2000	4	1.6L	GA16DE		FR3LS		41800	1.1
Nissan	Pulsar	N15	10/95	06/00	4	2.0L	SR20DE		41629		41800	1.1
Nissan	Pulsar	N16	07/99	05/03	4	1.8L	QG18DE	Sedan	41629		41800	1.1
Nissan	Pulsar	N16	06/03	01/06	4	1.8L	QG18DE	Sedan			41835*	1.1
Nissan	Pulsar	N16	06/01	07/02	4	1.8L	QG18DE	Hatch	41629		41800	1.1
Nissan	Pulsar	N16	08/02	01/06	4	1.8L	QG18DE	Hatch			41835*	1.1
Nissan	Pulsar	N16	2000	2005	4	1.6L	QG16DE		41629		41969*	0.9
Nissan	Pulsar	B17	02/13	on	4	1.8L	MRA8DE	Sedan			41964*	1.1
Nissan	Pulsar	C12	02/13	on	4	1.8L	MRA8DE	Hatch			41964*	0.9
Nissan	Serena	AC23	10/92	1995	4	2.0L	SR20DE		41629		41969*	0.9
Nissan	Silvia	S13	01/91	09/93	4	2.0L	SR20DET	Turbo	41602	AC5	41970*	0.9
Nissan	Skyline	C210	03/78	1980	4	2.4L	L24		R42XLS	AC4	41804	0.8
Nissan	Skyline	R30	03/81	1986	4	2.4L	L24E	EFI	R42XLS	AC4	41804	1.1
Nissan	Skyline	R31	07/86	1990	6	3.0L	RB30E	EFI	41602	AC5	41801	1.1
Nissan	Skyline	R32 - GTS25 Type S	08/91	07/93	6	2.5L	RB25DE				41825	1.1
Nissan	Skyline	R32 - GTS25 Type X	08/91	07/93	6	2.5L	RB25DE				41825	1.1
Nissan	Skyline	R33 - GTS25	08/93	12/95	6	2.5L	RB25DE	Coupe			41800	1.1
Nissan	Skyline	R33 - GTS25	08/93	04/98	6	2.5L	RB25DE	Sedan			41800	1.1
Nissan	Skyline	R33 - GTS25 Type M	08/93	14/98	6	2.5L	RB25DET				41800	1.1
Nissan	Skyline	R33 - GTS25 Type S	08/93	04/98	6	2.5L	RB25DE				41800	1.1
Nissan	Skyline	R33 - GTS-4	11/93	04/98	6	2.5L	RB25DE				41800	1.1
Nissan	Skyline	R33 - GTS25 Type G	06/94	12/95	6	2.5L	RB25DET				41800	1.1
Nissan	Skyline GT	R31	08/85	04/89	6	2.0L	RB20DE		41602	AC5	41801	1.1
Nissan	Skyline GT	R31	08/85	04/89	6	2.0L	RB20DET	Turbo	41602	AC5	41801	1.1
Nissan	Skyline GT	R32	05/89	07/93	6	2.0L	RB20DE		41602	AC5	41801	1.1
Nissan	Skyline GT	R32	05/89	07/93	6	2.0L	RB20DET	Turbo	41602	AC5	41801	1.1
Nissan	Skyline GT	R32	08/89	12/94	6	2.6L	RB26DETT	Twin Turbo	41602	AC5	41801	1.1
Nissan	Skyline GT	R33	01/95	12/98	6	2.6L	RB26DETT	Twin Turbo	41602	AC5	41801	1.1
Nissan	Skyline GT	R34	01/99	08/02	6	2.6L	RB26DETT	Twin Turbo	41602	AC5	41801	1.1
Nissan	Stanza		1978	1983	4	1.6L	L16		43XLS	AC4		0.8
Nissan	Sunny		1978	1982	4	1.4L	A14		43XLS	AC4		0.8
Nissan	Sunny		1979	1991	4	1.2L	A12		43XLS	AC4		0.8
Nissan	Sunny		1979	1981	4	1.5L	A15		43XLS	AC4		0.8
Nissan	Terrano II	R20	03/97	2000	4	2.4L	KA24E				41806	1.0
Nissan	Tiida	C11	02/06	2014	4	1.8L	MR18DE				41964*	1.1
Nissan	Urvan	E23	1980	1982	4	2.0L	H20		43XLS	AC4		0.8
Nissan	Urvan	E23	1982	1986	4	2.0L	Z20		43XLS	AC4		0.8
Nissan	Urvan	E24	03/87	1993	4	2.4L	Z24S		R42XLS	AC4	41804	0.8

MAKE	MODEL	SERIES / BADGE	FROM	TO	CYLS	CAPACITY	ENGINE	ADDITIONAL INFORMATION	REGULAR	PLATINUM (RAPIDFIRE®)	DOUBLE PLATINUM	GAP (MM)#
Nissan	Vanette	C120	1980	1985	4	1.2L	A12		R43XLS	AC4		0.8
Nissan	Vanette	C120	1981	1989	4	1.5L	A15		R43XLS	AC4		0.8
Nissan	Vanette	C20	1983	1986	4	1.2L	A12		R43XLS	AC4		0.8
Nissan	Vanette	C20	1983	1986	4	1.5L	A15		R43XLS	AC4		0.8
Nissan	Vanette	C22	12/86	1988	4	2.0L	Z20S		R42XLS	AC4	41804	0.8
Nissan	Vanette	C22	04/88	1993	4	2.0L	Z20S	Exhaust	R43XLS	AC4		0.8
Nissan	Vanette	C22	04/88	1993	4	2.0L	Z20S	Inlet	R43XLS	AC4		0.8
Nissan	Vanette	NV200 M20	2009	2018	4	1.6L	HR16DE				41964*	1.1
Nissan	Wingroad	Y12	2006	2007	4	1.8L	MR18DE				41964*	1.1
Nissan	X-Trail	T30	2001	2003	4	2.5L	QR25DE	132kW			41835*	1.1
Nissan	X-Trail	T30	02/2006	09/2007	4	2.5L	QR25DE	14mm Thread Only 123kW			41835*	1.1
Nissan	X-Trail	T30 Series II	2003	2007	4	2.5L	QR25DE	14mm Thread Only 132kW			41835*	1.1
Nissan	X-Trail	T31	10/07	2014	4	2.5L	QR25DE				41964*	1.1
Nissan	X-Trail	T31	01/11	04/12	4	2.0L	MR20DE				41964*	1.1
Nissan	X-Trail	T31 Ser 5	05/12	on	4	2.0L	MR20DE				41964*	1.1
Nissan	X-Trail	T31 Ser 5	05/12	on	4	2.5L	QR25DE				41964*	1.1
OLDSMOBILE												
Oldsmobile	442		1966	1966	8	6.6L		4 BBL			41833	0.8
Oldsmobile	442		1967	1967	8	6.6L		4 BBL Vin VG			41833	0.8
Oldsmobile	442		1968	1968	8	5.7L		CARB			41833	0.8
Oldsmobile	442		1968	1968	8	6.6L		2 BBL Vin QL			41833	0.8
Oldsmobile	442		1969	1969	8	6.6L		4 BBL Vin QW QR QS			41833	0.8
Oldsmobile	442		1970	1970	8	5.7L		CARB			41833	0.8
Oldsmobile	442		1970	1970	8	7.5L		4 BBL Vin UN UO			41833	0.8
Oldsmobile	Custom Cruiser		1985	1990	8	5.0L		4 BBL Vin Y		AC5		1.1
Oldsmobile	Cutlass		1966	1966	8	5.4L		2 BBL			41833	0.8
Oldsmobile	Cutlass		1966	1968	8	6.6L		CARB			41833	0.8
Oldsmobile	Cutlass		1967	1967	8	5.4L		2 BBL Vin VW WE			41833	0.8
Oldsmobile	Cutlass		1968	1969	8	5.7L		2 BBL Vin QL QA QB QJ			41833	0.8
Oldsmobile	Cutlass		1970	1970	8	5.7L		2 BBL Vin QA QJ QI			41833	0.8
Oldsmobile	Cutlass		1970	1970	8	7.5L		2 BBL Vin TX TY			41833	0.8
Oldsmobile	Cutlass		1985	1987	8	5.0L		CARB Vin Y		AC5		1.1
Oldsmobile	Cutlass Supreme		1970	1970	8	5.7L		CARB			41833	0.8
Oldsmobile	Cutlass Supreme		1985	1998	8	5.0L		4 BBL Vin Y		AC5		1.1
Oldsmobile	Cutlass Supreme		1986	1987	8	5.0L		4 BBL Vin 9		AC5		1.1
OPEL												
Opel	Astra	J	09/12	on	4	1.6L	A16LET				41982*	0.8
PEUGEOT												
Peugeot	205		1984	1994	4	1.6L	XU5J		41629		41969*	0.9

MAKE	MODEL	SERIES / BADGE	FROM	TO	CYLS	CAPACITY	ENGINE	ADDITIONAL INFORMATION	REGULAR	PLATINUM (RAPIDFIRE®)	DOUBLE PLATINUM	GAP (MM)#
Peugeot	205		1987	1995	4	1.9L	XU9J		41629		41969*	0.9
Peugeot	206		09/99	06/07	4	1.6L	TU5JP	SOHC	41602	AC5	41970*	0.9
Peugeot	206	CC	10/01	06/07	4	1.6L	TU5JP4	DOHC			41835*	0.9
Peugeot	206		03/02	02/07	4	1.4L	TU3		41602	AC5	41970*	0.9
Peugeot	305		1979	1981	4	1.5L	XR5		R42LTS		41810	0.9
Peugeot	306		04/94	1995	4	1.8L	XU7	SOHC	41629		41969*	0.8
Peugeot	306		04/94	1997	4	2.0L	XU10J4	DOHC	FR1LS			0.8
Peugeot	306		07/95	1999	4	1.8L	XU7	SOHC	41629		41969*	0.9
Peugeot	306		11/95	1997	4	2.0L	XU10J2	SOHC	41629		41969*	0.8
Peugeot	306		07/97	1999	4	1.8L	XU7JP4	DOHC	41629		41969*	0.8
Peugeot	306		07/97	2001	4	2.0L	XU10J4	DOHC	41629		41969*	0.8
Peugeot	306	GTi	07/97	1999	4	2.0L	XU10J4	DOHC	41602		41970*	0.8
Peugeot	306		08/99	2000	4	1.8L	XU7JP4	DOHC	41629		41969*	0.9
Peugeot	306	GTi	10/99	2000	4	2.0L	EW10J4	DOHC	41602		41970*	0.8
Peugeot	306	Cabriolet	01/02	on	4	2.0L	XU10J4	DOHC	41629		41969*	0.8
Peugeot	307		12/01	06/08	4	1.6L	TU5JP4	DOHC			41835*	0.9
Peugeot	405		02/89	1993	4	1.9L	XU9J2		41629		41969*	0.8
Peugeot	405	Mi16	02/89	1993	4	1.9L	XU9J4		41602		41970*	0.8
Peugeot	405		05/93	1996	4	2.0L	XU10J2		41629		41969*	0.8
Peugeot	405	Mi16	05/93	1996	4	2.0L	XU10J4		41602		41970*	0.8
Peugeot	405		1995	08/96	4	2.0L			41602		41970*	0.8
Peugeot	406	ST D8	10/96	1999	4	2.0L	XU10J4		41629		41969*	0.8
Peugeot	406	SV Coupe	10/97	10/99	6	3.0L	ES9J4		41602	AC5	41801	1.0
Peugeot	406	D9	09/00	10/04	6	3.0L	ES9J4S				41835*	1.1
Peugeot	407		09/04	08/09	6	3.0L	ES9A				41835*	1.1
Peugeot	504		1970	1971	4	1.8L	XM7		R43XLS	AC4		0.8
Peugeot	504		1970	1983	4	2.0L	XN2		R43XLS	AC4		0.8
Peugeot	505		10/80	12/80	4	2.0L			R43XLS	AC4		0.8
Peugeot	604		04/78	1982	6	2.7L	ZM		R42LTS		41810	0.9
Peugeot	607		2001	2005	6	3.0L	ES9J4S				41835*	1.1
PLYMOUTH												
Plymouth	Barracuda		1967	1969	8	6.3L		4 BBL Vin H			41833	0.8
Plymouth	Barracuda		1970	1971	8	6.3L		4 BBL Vin N			41833	0.8
Plymouth	Barracuda		1970	1971	8	7.2L		3x2 BBL Vin V			41833	0.8
Plymouth	Barracuda		1970	1970	8	7.2L		4 BBL Vin U			41833	0.8
Plymouth	Belvedere		1966	1966	8	5.2L		2 BBL Vin F			41833	0.8
Plymouth	Belvedere		1966	1966	8	5.9L		2 BBL			41833	0.8
Plymouth	Belvedere		1966	1966	8	6.3L		4 BBL Vin H			41833	0.8
Plymouth	Belvedere		1966	1966	8	7.2L		CARB Vin K			41833	0.8
Plymouth	Belvedere		1967	1967	8	7.2L		CARB			41833	0.8
Plymouth	Belvedere		1968	1969	8	6.3L		4 BBL Vin H			41833	0.8
Plymouth	Belvedere		1970	1970	8	6.3L		4 BBL Vin N			41833	0.8
Plymouth	Belvedere II		1966	1966	8	5.2L		CARB Vin F			41833	0.8
Plymouth	Belvedere II		1966	1966	8	5.9L		CARB			41833	0.8
Plymouth	Belvedere II		1966	1966	8	6.3L		CARB Vin H			41833	0.8
Plymouth	Belvedere II		1967	1967	8	7.2L		CARB			41833	0.8
Plymouth	Cuda		1970	1971	8	6.3L		CARB Vin N			41833	0.8

MAKE	MODEL	SERIES / BADGE	FROM	TO	CYLS	CAPACITY	ENGINE	ADDITIONAL INFORMATION	REGULAR	PLATINUM (RAPIDFIRE®)	DOUBLE PLATINUM	GAP (MM)#
Plymouth	Roadrunner		1968	1969	8	6.3L		4 BBL Vin H			41833	0.8
Plymouth	Roadrunner		1969	1969	8	7.2L		3x2 BBL Vin M			41833	0.8
Plymouth	Roadrunner		1970	1971	8	6.3L		4 BBL Vin N			41833	0.8
Plymouth	Roadrunner		1970	1972	8	7.2L		3x2 BBL Vin V			41833	0.8
Plymouth	Roadrunner		1970	1974	8	7.2L		4 BBL Vin U			41833	0.8
Plymouth	Roadrunner		1972	1975	8	6.6L		CARB Vin P			41833	0.8
Plymouth	Roadrunner		1973	1973	8	6.6L		2 BBL Vin M			41833	0.8
Plymouth	Roadrunner		1975	1975	8	6.6L		CARB Vin N			41833	0.8
PONTIAC												
Pontiac	Bonneville		1966	1966	8	6.9L		4 BBL			41833	0.8
Pontiac	Bonneville		1967	1969	8	7.0L		4 BBL Vin WJ YK			41833	0.8
Pontiac	Bonneville		1968	1968	8	6.6L		2 BBL Vin YA			41833	0.8
Pontiac	Bonneville		1968	1968	8	7.0L		4 BBL Vin WG YH			41833	0.8
Pontiac	Bonneville		1969	1969	8	6.6L		2 BBL Vin YA YB			41833	0.8
Pontiac	Bonneville		1970	1971	8	6.6L		CARB			41833	0.8
Pontiac	Bonneville		1970	1970	8	7.5L		4 BBL Vin YC YA XF			41833	0.8
Pontiac	Bonneville		1971	1971	8	7.5L		2 BBL Vin WG YG			41833	0.8
Pontiac	Catalina		1966	1966	8	6.9L		4 BBL			41833	0.8
Pontiac	Catalina		1967	1967	8	7.0L		4 BBL Vin WJ XK Y2 Y3 YK			41833	0.8
Pontiac	Catalina		1968	1968	8	6.6L		2 BBL Vin WA WB YA			41833	0.8
Pontiac	Catalina		1968	1969	8	7.0L		4 BBL Vin WJ YK			41833	0.8
Pontiac	Catalina		1969	1969	8	6.6L		2 BBL Vin YA YB			41833	0.8
Pontiac	Catalina		1970	1970	8	6.6L		2 BBL Vin XX YB			41833	0.8
Pontiac	Catalina		1970	1970	8	7.5L		4 BBL Vin YC YA XF			41833	0.8
Pontiac	Catalina		1971	1971	8	6.6L		2 BBL Vin WS WX XX XY			41833	0.8
Pontiac	Catalina		1971	1971	8	7.5L		2 BBL Vin WG YG			41833	0.8
Pontiac	Firebird		1967	1967	8	6.6L		4 BBL Vin WJ WQ XN			41833	0.8
Pontiac	Firebird		1968	1969	8	6.6L		4 BBL Vin WQ YW XN			41833	0.8
Pontiac	Firebird		1970	1970	8	6.6L		2 BBL Vin XX YB			41833	0.8
Pontiac	Firebird		1985	1985	8	5.0L		4 BBL Vin G	R44TS			1.1
Pontiac	Firebird		1994	1997	8	5.7L		F/I Vin P		AC14		1.5
Pontiac	Firebird		2002	2002	8	5.7L		F/I Vin G		AC6		1.1
Pontiac	Firebird Formula		1993	1996	8	5.7L		F/I Vin P		AC14		1.5
Pontiac	Firebird Formula		1993	1993	8	5.7L		F/I Vin P	R44LTS6			1.5
Pontiac	Firebird Formula		1998	2001	8	5.7L		F/I Vin G		AC6		1.1
Pontiac	Grand Prix		1966	1966	8	6.9L		4 BBL			41833	0.8
Pontiac	Grand Prix		1967	1967	8	7.0L		4 BBL Vin WJ XK YK WL			41833	0.8
Pontiac	Grand Prix		1968	1968	8	6.6L		2 BBL Vin YA			41833	0.8

MAKE	MODEL	SERIES / BADGE	FROM	TO	CYLS	CAPACITY	ENGINE	ADDITIONAL INFORMATION	REGULAR	PLATINUM (RAPIDFIRE®)	DOUBLE PLATINUM	GAP (MM)#
Pontiac	Grand Prix		1968	1968	8	7.0L		4 BBL Vin WG YH			41833	0.8
Pontiac	Grand Prix		1969	1969	8	6.6L		2 BBL Vin YF			41833	0.8
Pontiac	Grand Prix		1969	1969	8	7.0L		4 BBL Vin VWL XG			41833	0.8
Pontiac	Grand Prix		1970	1970	8	6.6L		4 BBL Vin VWX YS XH			41833	0.8
Pontiac	Grand Prix		1970	1970	8	7.5L		4 BBL Vin WA WG YC YA XF			41833	0.8
Pontiac	Grand Prix		1971	1971	8	6.6L		4 BBL Vin WT WK YS			41833	0.8
Pontiac	Grand Prix		1971	1971	8	7.5L		4 BBL Vin WJ YC			41833	0.8
Pontiac	Grand Prix		1980	1980	8	5.0L		4 BBL Vin H	R44TS			1.1
Pontiac	Grand Prix		2005	2007	8	5.3L		F/I Vin C		AC6		1.0
Pontiac	Grandville		1971	1971	8	6.6L		CARB			41833	0.8
Pontiac	Grandville		1971	1971	8	7.5L		4 BBL Vin WJ YC			41833	0.8
Pontiac	GTO		1967	1967	8	6.6L		2 BBL Vin XM XL			41833	0.8
Pontiac	GTO		1968	1968	8	6.6L		2 BBL Vin XM			41833	0.8
Pontiac	GTO		1969	1969	8	6.6L		2 BBL Vin XX XM			41833	0.8
Pontiac	GTO		1970	1970	8	5.7L		CARB			41833	0.8
Pontiac	GTO		1970	1970	8	6.6L		4 BBL Vin VWS YZ			41833	0.8
Pontiac	GTO		1970	1970	8	7.5L		4 BBL Vin YC YA XF			41833	0.8
Pontiac	GTO		2004	2004	8	5.7L		F/I		AC6		1.1
Pontiac	GTO		2005	2005	8	6.0L		F/I Vin H		AC6		1.0
Pontiac	GTO		2006	2006	8	6.0L		F/I Vin U		AC6		1.0
PROTON												
Proton	Jumbuck	Ute	02/03	on	4	1.5L	4G15P		R43XLS	AC4	41802	1.1
Proton	M21	Coupe	09/97	2000	4	1.8L	4G93P		41602	AC5	41801	1.1
Proton	Persona		11/96	2004	4	1.5L	4G15P		R43XLS	AC4	41802	1.1
Proton	Persona		11/96	2000	4	1.6L	4G92P		41602	AC5	41801	1.1
Proton	Persona		04/99	2002	4	1.3L	4G1P		R43XLS	AC4	41802	1.1
Proton	Satria		02/97	01/05	4	1.5L	4G15P		R43XLS	AC4	41802	1.1
Proton	Satria		02/97	2000	4	1.6L	4G92P		41602	AC5	41801	1.1
Proton	Satria		07/99	2002	4	1.3L	4G1P		R43XLS	AC4	41802	1.1
Proton	Satria	GTi	09/99	01/07	4	1.8L	4G93PA		41602	AC5	41801	1.1
Proton	Waja	CF	11/01	2005	4	1.6L	4G18P		41629		41800	1.1
Proton	Wira		05/95	1996	4	1.5L	4G15		R43XLS	AC4	41802	1.1
Proton	Wira		05/95	1996	4	1.6L	4G92		41602	AC5	41801	1.1
RENAULT												
Renault	20		1979	1983	4	2.0L			R42XLS	AC4	41804	0.8
Renault	Clio	CB1	12/01	08/08	4	1.4L	K4JC		41602	AC5	41970*	0.9
Renault	Clio	CB1	12/01	06/06	4	1.6L	K4MA		41629		41969*	0.9
Renault	Clio	RS	12/01	on	4	2.0L	F4RD	BB1	41602	AC5	41801	1.0
Renault	Fuego		08/84	1988	4	2.0L	J6R		R42LTS		41810	0.9
Renault	Fluence	X38	2010	2018	4	2.0L	M4R.714/751				41964*	0.9
Renault	Kangoo		08/04	on	4	1.6L	K4AM		41629		41969*	0.9
Renault	Koleos	H45	09/08	on	4	2.5L	2TR				41964*	1.1

MAKE	MODEL	SERIES / BADGE	FROM	TO	CYLS	CAPACITY	ENGINE	ADDITIONAL INFORMATION	REGULAR	PLATINUM (RAPIDFIRE®)	DOUBLE PLATINUM	GAP (MM)#
Renault	Laguna		04/95	1996	4	2.0L	F3R		R43XLS	AC4	41802	0.9
Renault	Laguna		04/95	1996	6	3.0L	Z7X		41602	AC5	41970*	0.9
Renault	Laguna		03/02	01/06	6	3.0L	L7XE		41602	AC5	41801	1.0
Renault	Laguna		09/02	01/11	6	2.0L	F4RK		41602	AC5	41970*	0.9
Renault	Megane	Cabrio	06/01	2003	4	1.6L	K4M		41602	AC5	41970*	0.9
Renault	Megane	CC Cabrio	2004	on	4	2.0L			41602	AC5	41970*	0.9
Renault	Megane		09/04	on	4	2.0L	F4R	Turbo	FR1LS			0.9
Renault	Megane II		12/03	12/07	4	1.6L	K4M		41602	AC5	41970*	0.9
Renault	Megane II		12/03	10/10	4	2.0L	F4RC		FR1LS			0.9
Renault	Megane	B95	2013	2014	4	2.0L	M4R.711/713				41964*	1.1
Renault	Megane	E95	2010	2018	4	2.0L	M4R.711/713				41964*	1.1
Renault	Megane	K95	2013	2014	4	2.0L	M4R.711/713				41964*	1.1
Renault	Megane	X32	2010	2013	4	2.0L	M4R.711/713				41964*	1.1
Renault	R21		03/88	1991	4	2.2L	J7T		R42LTS		41810	0.9
Renault	Scenic		05/01	2005	4	1.6L	K4M		41629		41969*	0.9
Renault	Scenic		05/01	2005	4	1.6L	KM4A700		41629		41969*	0.9
Renault	Scenic		05/01	03/09	4	2.0L	F4R		41602	AC5	41970*	0.9
Renault	Scenic		05/01	03/09	4	2.0L	F4RC		41602	AC5	41970*	0.9
Renault	Virage		10/76	1980	4	1.4L			R42LTS		41810	0.9
ROVER												
Rover	75		03/01	2004	6	2.5L	25K		41602	AC5	41801	1.1
Rover	416		1993	1990	4	1.6L			41602	AC5	41801	1.1
Rover	827		1986	1996	6	2.7L			41602	AC5	41801	1.1
Rover	2000	SC	1963	1973	4	2.0L			R42XLS	AC4	41804	0.8
Rover	2000	TC	1966	1973	4	2.0L			R42XLS	AC4	41804	0.8
Rover	2200	SC	1973	1977	4	2.2L			R42XLS	AC4	41804	0.8
Rover	2200	TC	1973	1977	4	2.2L			R42XLS	AC4	41804	0.8
Rover	3500		1967	1973	8	3.5L	3.5		R43XLS	AC4		0.8
Rover	3500		1968	1977	8	3.5L	11A		R43XLS	AC4		0.8
Rover	3500	SD1	1976	1986	8	3.5L	11A		R43XLS	AC4		0.8
Rover	825Si		1996	1997	6	2.5L			41602	AC5	41801	1.1
Rover	Quintet		05/83	1986	4	1.6L	EL		R43XLS	AC4		0.8
Rover	Vitesse		1988	1991	6	2.7L			41602	AC5	41801	1.1
SAAB												
Saab	900		03/79	1988	4	2.0L	B201	8V SOHC	R42XLS		41804	0.7
Saab	900		03/79	1985	4	2.0L	BS120	8V SOHC Turbo	R42XLS		41804	0.7
Saab	900		12/94	1998	4	2.0L	B204L	16V DOHC Turbo			41825	1.0
Saab	9000		1986	1991	4	2.0L	B202L	16V DOHC Turbo			41825	1.0
Saab	9000		05/90	1996	4	2.3L	B234	16V DOHC			41825	1.0
Saab	9000		03/91	1998	4	2.3L	B234R	16V DOHC Turbo			41825	1.0
Saab	9000		1992	1993	4	2.0L	B202S	16V DOHC Turbo			41825	1.0
Saab	9000		1993	1998	4	2.3L	B234E		FR1LS			1.1
Saab	9-3		06/98	1999	4	2.0L	B204ID	DOHC 96kW			41825	1.0
Saab	9-3		06/98	2000	4	2.0L	B204LD	DOHC Turbo 136kW			41825	1.0
Saab	9-3		06/98	2000	4	2.0L	B204R	DOHC Turbo 147kW			41825	1.0

MAKE	MODEL	SERIES / BADGE	FROM	TO	CYLS	CAPACITY	ENGINE	ADDITIONAL INFORMATION	REGULAR	PLATINUM (RAPIDFIRE®)	DOUBLE PLATINUM	GAP (MM)#
Saab	9-3		06/98	1999	4	2.3L	B234ID	DOHC 110kW			41825	1.0
Saab	9-3		01/99	2001	4	2.0L	B204ED	DOHC Turbo 113kW			41825	1.0
Saab	9-3		08/99	2000	4	2.3L	B235RD	DOHC Turbo 165kW			41825	1.0
Saab	9-3		02/00	2001	4	2.0L		DOHC Turbo			41825	1.0
Saab	9-3		02/00	10/03	4	2.0L	B205RDM	DOHC Turbo 151kW			41825	1.0
Saab	9-3		08/00	2001	4	2.3L	B235RG	DOHC Turbo 169kW			41825	1.0
Saab	9-3		02/01	2002	4	2.0L	B205E	DOHC Turbo 110kW			41825	1.0
Saab	9-3		01/02	on	4	2.0L		DOHC Turbo 129kW			41825	1.0
Saab	9-3		11/02	on	4	2.0L		110kW DOHC Turbo			41825	1.0
Saab	9-3		11/02	10/07	4	2.0L	B207E	DOHC Turbo 136kW			41825	1.0
Saab	9-3		05/03	on	4	2.0L		155kW DOHC Turbo			41825	1.0
Saab	9-3		10/03	on	4	2.0L	B207R	DOHC Turbo 136kW			41825	1.0
Saab	9-5		1974	2000	4	2.0L	B205LE	DOHC Turbo			41825	1.0
Saab	9-5		11/97	2001	4	2.3L	B235LE	DOHC Turbo 125kW			41825	1.0
Saab	9-5		1999	2009	4	2.3L	B235R	Turbo			41825	1.0
Saab	9-5		03/99	2001	6	3.0L	B304EEA	24V Turbo 147kW			41825	1.0
Saab	9-5		07/99	2002	4	2.0L	B205EEM	DOHC Turbo 110kW			41825	1.0
Saab	9-5		02/00	2001	4	2.3L	B235REM	DOHC Turbo 169kW			41825	1.0
Saab	9-5		11/01	on	4	2.3L	B235EEM	DOHC Turbo 125kW			41825	1.0
SEAT												
Seat	Cordoba		1995	1996	4	1.8L	ABS		R42XLS	AC4	41804	0.8
Seat	Cordoba		01/95	1999	4	1.8L	ADZ		R42XLS	AC4	41804	0.8
Seat	Cordoba		09/98	1999	4	1.6L	AEE		R42XLS	AC4	41804	0.8
Seat	Cordoba		09/98	1999	4	1.6L	AFT		41629		41969*	0.8
Seat	Ibiza	GTi	01/95	1998	4	2.0L	2E	SOHC	R42XLS	AC4	41804	0.8
Seat	Ibiza	Cupra	09/98	1999	4	2.0L	ABF	DOHC 16V	FR1LS			0.8
Seat	Toledo	GLX	01/95	1998	4	2.0L	2E		R42XLS	AC4	41804	0.8
Seat	Toledo	Magnus	01/95	1997	4	2.0L	AGG		R42XLS	AC4	41804	0.8
Seat	Toledo		10/95	1998	4	2.0L	ABF	16V	FR1LS			0.8
SHELBY												
Shelby	Series 1		1999	2000	8	4.0L		F/I			41963*	1.3
SKODA												
Skoda	Octavia	1Z	2007	2009	4	1.8L	BZB		41602		41970*	0.8
Skoda	Octavia	1Z	2007	2009	4	2.0L	BVY				41806	1.0
Skoda	Octavia	1Z	2007	2010	4	2.0L	BWA	Turbo			41970*	0.7
Skoda	Octavia	1Z	2007	on	4	2.0L	CCZ	Turbo	41602		41970*	0.8
Skoda	Octavia	1Z	2010	on	4	1.8L	CDA	Turbo	41602		41970*	0.8
Skoda	Superb	3T	2009	on	4	1.8L	CDA	Turbo	41602		41970*	0.8

MAKE	MODEL	SERIES / BADGE	FROM	TO	CYLS	CAPACITY	ENGINE	ADDITIONAL INFORMATION	REGULAR	PLATINUM (RAPIDFIRE®)	DOUBLE PLATINUM	GAP (MM)#
SMART												
Smart	E450		05/03	01/08	3	0.7L	M15028	Turbo			41970*	0.6
SSANGYONG												
Ssangyong	Korando		02/98	07/98	4	2.3L	M161		41602		41970*	0.8
Ssangyong	Korando	C200	2012	2018	4	2.0L	M172.950				41968*	1.1
Ssangyong	Musso		07/96	2000	6	3.2L			41629		41969*	0.8
Ssangyong	Musso		09/97	07/98	4	2.3L			41629		41969*	0.8
SUBARU												
Subaru	1400		05/76	1980	4	1.4L	EA63		R42XLS	AC4	41804	0.8
Subaru	1600		05/76	1980	4	1.6L	EA71		R42XLS	AC4	41804	0.8
Subaru	1800		10/80	11/84	4	1.8L	EA81		R42XLS	AC4	41804	0.8
Subaru	Brumby		1982	1984	4	1.8L	EA81		R42XLS	AC4	41804	0.8
Subaru	Exiga	YA	2009	2018	4	2.5L	EJ253				41966*	1.1
Subaru	Fiori	KN4	03/90	1992	4	0.758L	EN08		41629		41969*	0.8
Subaru	Forester	SF	08/97	2000	4	2.0L	EJ20	SOHC	41629		41800	1.1
Subaru	Forester	SF	09/98	2002	4	2.0L	EJ205	GT Turbo	41602		41970*	0.8
Subaru	Forester	SF	01/00	2002	4	2.0L	EJ20	DOHC	41602	AC5	41801	1.1
Subaru	Forester	SG	07/02	06/05	4	2.5L	EJ251				41801	1.1
Subaru	Forester	SG	07/05	02/08	4	2.5L	EJ253				41800	1.1
Subaru	Forester	SH	03/08	01/11	4	2.5L	EJ253				41800	1.1
Subaru	Forester	SH	02/11	01/13	4	2.5L	FB25	X, XS			41968*	1.1
Subaru	Forester	SJ	01/13	on	4	2.0L	FB20				41968*	1.1
Subaru	Forester	SJ	01/13	on	4	2.5L	FB25	2.5i			41968*	1.1
Subaru	Impreza		02/94	2005	4	2.0L	EJ20T	Turbo	41602		41970*	0.8
Subaru	Impreza	GC	1993	1998	4	1.6L	EJ16		41602	AC5	41801	1.1
Subaru	Impreza	GC	1993	1996	4	1.8L	EJ18E		41602	AC5	41801	1.1
Subaru	Impreza	GC	1996	1998	4	2.0L	EJ20E		41602	AC5	41801	1.1
Subaru	Impreza	GD	09/98	08/07	4	2.0L	EJ201				41970*	0.8
Subaru	Impreza	GD	10/00	09/05	4	2.0L	EJ205	WRX Turbo			41970*	0.8
Subaru	Impreza	GD	12/01	09/05	4	2.0L	EJ207	WRX Turbo STI			41970*	0.8
Subaru	Impreza	GE	09/08	on	4	2.0L	EJ204				41835*	1.1
Subaru	Impreza	GF	04/93	11/96	4	1.8L	EJ18E		41602	AC5	41801	1.1
Subaru	Impreza	GF	1996	1999	4	2.0L	EJ20E		41602	AC5	41801	1.1
Subaru	Impreza	GF	11/96	09/98	4	1.6L	EJ16		41602	AC5	41801	1.1
Subaru	Impreza	GG	09/98	08/07	4	2.0L	EJ201				41970*	0.8
Subaru	Impreza	GG	10/00	09/05	4	2.0L	EJ205	WRX Turbo			41970*	0.8
Subaru	Impreza	GG	10/01	09/05	4	2.5L	EJ251				41801	1.1
Subaru	Impreza	GH	09/08	on	4	2.0L	EJ204				41835*	1.1
Subaru	Impreza	GJ	01/12	on	4	2.0L	FB20	Sedan			41968*	1.1
Subaru	Impreza	GP	01/12	on	4	2.0L	FB20	Wagon			41968*	1.1
Subaru	Legacy	BM	2009	2012	4	2.5L	EJ253				41966*	1.1
Subaru	Legacy	BR	2009	2012	4	2.5L	EJ253				41966*	1.1
Subaru	Leone		1975	1981	4	1.6L	EA71		R42XLS	AC4	41804	0.8
Subaru	Leone		1980	1984	4	1.8L	EA81		R42XLS	AC4	41804	0.8
Subaru	Leone		11/85	1990	4	1.8L	EA82		R42XLS	AC4	41804	1.1
Subaru	Liberty	BC	10/89	06/94	4	2.2L	EJ22		41602	AC5	41801	1.1
Subaru	Liberty	BC	10/91	1994	4	2.0L	EJ20G	RS Turbo	41602		41970*	0.8

MAKE	MODEL	SERIES / BADGE	FROM	TO	CYLS	CAPACITY	ENGINE	ADDITIONAL INFORMATION	REGULAR	PLATINUM (RAPIDFIRE®)	DOUBLE PLATINUM	GAP (MM)#
Subaru	Liberty	BD	06/94	03/99	4	2.2L	EJ22		41602	AC5	41801	1.1
Subaru	Liberty	BD	11/96	1999	4	2.5L	EJ25D		41629		41800	1.1
Subaru	Liberty	BE	03/99	2003	4	2.0L	EJ201		41602	AC5	41801	1.1
Subaru	Liberty	BE	03/99	2003	4	2.5L	EJ251		41602	AC5	41801	1.1
Subaru	Liberty	BF	10/89	06/94	4	2.2L	EJ22		41602	AC5	41801	1.1
Subaru	Liberty	BF	10/92	1994	4	2.0L	EJ20G	RS Turbo	41602		41970*	0.8
Subaru	Liberty	BG	06/94	03/99	4	2.2L	EJ22		41602	AC5	41801	1.1
Subaru	Liberty	BG	11/96	1999	4	2.5L	EJ25D		41629		41800	1.1
Subaru	Liberty	BH	03/99	2003	4	2.0L	EJ201		41602	AC5	41801	1.1
Subaru	Liberty	BH	03/99	2003	4	2.5L	EJ251		41602	AC5	41801	1.1
Subaru	Liberty	BL	09/03	06/05	4	2.0L	EJ202				41800	1.1
Subaru	Liberty	BL	09/03	07/07	4	2.5L	EJ251				41800	1.1
Subaru	Liberty	BL	08/07	08/09	4	2.5L	EJ253				41800	1.1
Subaru	Liberty	BM	09/09	on	6	3.6L	EZ36D				41835*	1.1
Subaru	Liberty	BM	2009	2012	4	2.5L	EJ253				41966*	1.1
Subaru	Liberty	BP	09/03	06/05	4	2.0L	EJ202				41800	1.1
Subaru	Liberty	BP	09/03	07/07	4	2.5L	EJ251				41800	1.1
Subaru	Liberty	BP	08/07	08/09	4	2.5L	EJ253				41800	1.1
Subaru	Liberty	BR	09/09	on	4	2.5L	EJ25				41800	1.1
Subaru	Liberty	BV	09/09	on	4	2.5L	EJ25	GT Premium			41969*	0.8
Subaru	Liberty	YA	2009	2014	4	2.5L	EJ253				41966*	1.1
Subaru	Outback	BG	09/96	10/98	4	2.5L	EJ25		41602	AC5	41801	1.1
Subaru	Outback	BH	10/98	08/03	4	2.5L	EJ251				41801	1.1
Subaru	Outback	BH	10/00	08/03	6	3.0L	EZ30D				41835*	1.1
Subaru	Outback	BP	09/03	08/09	4	2.5L	EJ251				41800	1.1
Subaru	Outback	BR	2009	2012	4	2.5L	EJ253				41966*	1.1
Subaru	Outback	BR	09/09	on	6	3.6L	EZ36D				41835*	1.1
Subaru	Outback	BR	12/12	on	4	2.5L	FB25				41968*	1.1
Subaru	Sherpa	KM3	10/82	1989	2	0.665L	EK42		41602	AC5	41801	1.1
Subaru	Sherpa	KN3	1988	1989	2	0.665L	EK42		41602	AC5	41801	1.1
Subaru	Sherpa	KN4	09/89	1990	2	0.758L	EN08		41629		41969*	0.8
Subaru	SVX	CX	03/92	1997	6	3.3L	EG33M		41629		41800	1.1
Subaru	Vortex	XT	1985	1989	4	1.8L	EA82		R42XLS	AC4	41804	1.1
Subaru	Vortex	XT	1986	1989	4	1.8L	EA82T	Turbo	R42XLS	AC4	41804	1.1
Subaru	XV		01/12	on	4	2.0L	FB20				41968*	1.1
SUZUKI												
Suzuki	Aerio		2003	2007	4	1.8L	M18A				41966*	1.1
Suzuki	Alto	SS80V	11/80	1985	3	0.796L	F8B		R43XLS	AC4		0.8
Suzuki	Alto	SH410	03/96	1998	4	1.0L	G10B		R43XLS	AC4		0.8
Suzuki	Baleno		1996	2001	4	1.5L	G15A				41966*	1.1
Suzuki	Baleno	SY416	04/95	2001	4	1.6L	G16B		41602		41970*	0.8
Suzuki	Baleno	SY418	03/96	2000	4	1.8L	J18A		41602	AC5	41966*	1.1
Suzuki	Baleno	SY418	01/01	10/01	4	1.8L	J18A		41602	AC5	41966*	1.0
Suzuki	Carry	ST80	1978	1979	3	0.8L	F8A		R43XLS	AC4		0.8
Suzuki	Carry	ST90	1979	1985	3	0.8L	F8A		R43XLS	AC4		0.8
Suzuki	Carry	DA32V	05/99	2005	4	1.3L	G13BB		41602		41970*	0.8
Suzuki	Cino	SY413	05/94	1998	4	1.3L	G13B		R42XLS	AC4	41804	0.8
Suzuki	Cino	SY413	01/99	2000	4	1.3L	G13B		41602	AC5	41801	1.1

MAKE	MODEL	SERIES / BADGE	FROM	TO	CYLS	CAPACITY	ENGINE	ADDITIONAL INFORMATION	REGULAR	PLATINUM (RAPIDFIRE®)	DOUBLE PLATINUM	GAP (MM)#
Suzuki	Crescent		1996	2001	4	1.5L	G15A				41966*	1.1
Suzuki	Cultus		1991	2002	4	1.5L	G15A				41966*	1.1
Suzuki	Escudo		1997	2002	4	1.6L	G16A				41966*	1.1
Suzuki	Escudo		1997	2000	4	2.0L	J20A				41966*	1.1
Suzuki	Escudo		1997	2000	4	1.6L	G16A				41966*	1.1
Suzuki	Escudo		2005	2008	6	2.7	H27A				41966*	1.1
Suzuki	Grand Escudo		2000	2007	6	2.7	H27A				41966*	1.1
Suzuki	Grand Vitara	SQ625	04/98	2001	6	2.5L	H25A	LWB	41602	AC5	41966*	1.1
Suzuki	Grand Vitara	SQ420	05/98	2005	4	2.0L	J20A		41602	AC5	41966*	1.1
Suzuki	Grand Vitara	SQ416 Cabrio	02/00	2002	4	1.6L	H16A		41602	AC5	41801	1.1
Suzuki	Grand Vitara	SQ625	05/01	2005	6	2.5L	H25A	LWB	41629		41800	1.1
Suzuki	Grand Vitara	JA627	2001	2006	6	2.7L	H27A				41966*	1.1
Suzuki	Grand Vitara	JB416	2005	2008	4	1.6L	M16A		41602		41966*	1.1
Suzuki	Grand Vitara	JB420	2005	2008	4	2.0L	J20A		41602		41966*	1.1
Suzuki	Grand Vitara	JB627	2005	2008	6	2.7L	H27A		41602		41966*	1.1
Suzuki	Grand Vitara	JT	2008	on	4	2.4L	J24B				41835*	1.1
Suzuki	Grand Vitara	JT	2008	07/12	6	3.2L	N32A				41973*	1.1
Suzuki	Ignis	RG413	10/00	02/05	4	1.3L	M13A		41602	AC5	41966*	1.1
Suzuki	Ignis	RG415	08/03	02/05	4	1.5L	M15A		41629		41800	1.1
Suzuki	Jimny	SN413	10/98	2002	4	1.3L	G13BB	16V DOHC	41602		41970*	0.8
Suzuki	Jimny	SN413	09/00	on	4	1.3L	M13A	16V DOHC	41602	AC5	41801	1.1
Suzuki	Kizashi	FR	2010	on	4	2.4L	J24B				41835*	1.1
Suzuki	Liana	RC31	09/01	2004	4	1.6L	M16A		41602	AC5	41801	1.1
Suzuki	Liana	RH416	2001	2007	4	1.6L	M16A				41966*	1.1
Suzuki	Liana	RH418	2004	2007	4	1.8L	M18A		41602		41966*	1.1
Suzuki	Mighty Boy	SS40T	1985	1988	3	0.5L	F5A		43XLS	AC4		0.8
Suzuki	Sierra	SJ410	1981	1988	4	1.0L	F10A		43XLS	AC4		0.8
Suzuki	Sierra	SJ413	1983	1990	4	1.3L	G13A		43XLS	AC4		0.8
Suzuki	Sierra	SJ413	1989	1999	4	1.3L	G13BA		R43XLS	AC4		0.8
Suzuki	Super Carry	SK410	07/85	1992	4	1.0L	F10A		R43XLS	AC4		0.8
Suzuki	Swift		1984	1989	4	1.3L	G13A		R42XLS	AC4	41804	0.8
Suzuki	Swift	SA413	1984	1999	4	1.3L	G13		R42XLS	AC4	41804	0.8
Suzuki	Swift	ST310	1985	1995	3	1.0L	G10A		R42XLS	AC4	41804	0.8
Suzuki	Swift	SF413	1989	1999	4	1.3L	G13		R42XLS	AC4	41804	0.8
Suzuki	Swift	SF416	12/89	1995	4	1.6L	G16B		41602		41970*	0.8
Suzuki	Swift		2004	2018	4	1.3L	M13A				41966*	1.1
Suzuki	Swift		2003	2004	4	1.5L	M15A				41966*	1.1
Suzuki	Swift	RS415	2005	2010	4	1.5L	M15A				41966*	1.1
Suzuki	Swift	RS416	2006	2010	4	1.6L	M16A		41602		41966*	1.1
Suzuki	SX4		2006	01/10	4	2.0L	J20A		41602		41966*	1.1
Suzuki	SX4		2006	2014	4	1.5L	M15A				41966*	1.1
Suzuki	SX4		02/10	on	4	2.0L	J20B				41835*	1.1
Suzuki	Vitara	SE416	07/88	1994	4	1.6L	G16A	SWB	R43XLS	AC4		0.8
Suzuki	Vitara	SE416	08/91	1998	4	1.6L	G16B	SWB / LWB	41602		41970*	0.8
Suzuki	Vitara	SV620	04/95	1999	6	2.0L	H20A	LWB	41629		41969*	0.8
Suzuki	Vitara	SV420	05/97	2000	4	2.0L	J20A	SWB	41602	AC5	41966*	1.1
Suzuki	Vitara	SE416	10/98	2000	4	1.6L	G16B	SWB / LWB	41602	AC5	41801	1.1
Suzuki	Vitara	XL-7	07/01	2005	6	2.7L	H27A		41629		41800	1.0

MAKE	MODEL	SERIES / BADGE	FROM	TO	CYLS	CAPACITY	ENGINE	ADDITIONAL INFORMATION	REGULAR	PLATINUM (RAPIDFIRE®)	DOUBLE PLATINUM	GAP (MM)#
Suzuki	Wagon R		2001	2006	4	1.3L	M13A				41966*	1.1
Suzuki	X-90	SZ416	04/96	1998	4	1.6L	G16B		41602		41970*	0.8
TOYOTA												
Toyota	4 Runner	YN60	07/84	1985	4	2.0L	3Y		R43XLS	AC4		0.8
Toyota	4 Runner	YN63	1985	1989	4	2.2L	4Y		R43XLS	AC4		0.8
Toyota	4 Runner	YN63	1988	1989	4	2.2L	4YE	EFI	R43XLS	AC4	41802	1.1
Toyota	4 Runner	YN130	1989	1990	4	2.2L	4YE	EFI	R43XLS	AC4	41802	1.1
Toyota	4 Runner	RN130	05/89	1996	4	2.4L	22R	CARB	R43XLS	AC4	41802	0.9
Toyota	4 Runner	VZN130	10/90	1996	6	3.0L	3VZE	EFI	41629		41969*	0.8
Toyota	Alphard	ANH20R	2008	2015	4	2.4L	2AZFE				41966*	1.1
Toyota	Alphard	GGH20R	05/08	01/15	6	3.5L	2GRFE				41835*	1.1
Toyota	Alphard	MNH10R	2002	2008	6	3.0L	1MZFE				41966*	1.1
Toyota	Alphard	MNH15R	2002	2008	6	3.0L	1MZFE				41966*	1.1
Toyota	Altezza	AS200	1998	2005	4	2.0L	1GFE				41966*	1.1
Toyota	Altezza	RS200	1998	2005	4	2.0L	3SGE				41966*	1.1
Toyota	Aurion	GSV40R	10/06	03/12	6	3.5L	2GRFE				41835*	1.1
Toyota	Aurion	GSV50R	04/12	on	6	3.5L	2GRFE				41835*	1.1
Toyota	Aurion TRD	GSV50R	2006	2007	6	3.5L	2GRFE				41835*	1.1
Toyota	Avalon	MCX10R	07/00	2005	6	3.0L	1MZFE	DOHC	41602	AC5	41801	1.1
Toyota	Avenis	ACM20	12/01	10/03	4	2.0L	1AZFE		41602	AC5	41966*	1.1
Toyota	Avenis	ACM21R	2003	2010	4	2.4L	2AZFE				41966*	1.1
Toyota	Avenis	AZT251R	2005	2008	4	2.4L	2AZFSE				41966*	1.1
Toyota	Avenis	AZT255R	2003	2008	4	2.4L	2AZFSE				41966*	1.1
Toyota	Avenis	Verso	2004	11/10	4	2.4L	2AZFE		41602	AC5	41801	1.1
Toyota	Blade	AZE156R	2006	2012	4	2.4L	2AZFE				41966*	1.1
Toyota	Bundera	RJ70	11/84	1991	4	2.4L	22RC		R43XLS	AC4	41802	0.9
Toyota	Camry		1983	1987	4	1.8L	1S		R43XLS	AC4		0.8
Toyota	Camry	SXV10	03/83	08/97	4	2.2L	5SFE		41602	AC5	41801	1.1
Toyota	Camry	SV11	04/83	1987	4	2.0L	2SE		R43XLS	AC4		0.8
Toyota	Camry	SV20	05/87	1989	4	1.8L	1SI	EFI	R43XLS	AC4	41802	1.1
Toyota	Camry	SV21	05/87	1993	4	2.0L	3SFE	EFI			41825	1.1
Toyota	Camry	SV22	09/89	1991	4	2.0L	3SFC	CARB	41629		41800	1.1
Toyota	Camry	VCV10	1991	1995	6	3.0L	3VZFE				41825	1.1
Toyota	Camry	SDV10	03/93	03/98	4	2.2L	5SFE		41602	AC5	41966*	1.1
Toyota	Camry	VDV10	03/93	09/95	6	3.0L	3VZFE				41825	1.1
Toyota	Camry	SXV10R	1993	1997	4	2.2L	5SFE		41602	AC5	41966*	1.1
Toyota	Camry	SXV20	07/97	2002	4	2.2L	5SFE		41602	AC5	41801	1.1
Toyota	Camry	MCV20	08/97	2002	6	3.0L	1MZFE		41602	AC5	41801	1.1
Toyota	Camry	ACV30R	2001	2006	4	2.4L	2AZFE				41966*	1.1
Toyota	Camry	ACV36R	09/02	2006	4	2.4L	2AZFE		41602	AC5	41966*	1.1
Toyota	Camry	MCV36	10/02	2006	6	3.0L	1MZFE		41602	AC5	41801	1.1
Toyota	Camry	ACV40	07/06	01/12	4	2.4L	2AZFE		41602	AC5	41966*	1.1
Toyota	Camry Atara	ASV50R	12/11	on	4	2.5L	2ARFE				41835*	1.1
Toyota	Camry Hybrid	AHV40R	01/10	02/12	4	2.4L	2AZFXE				41966*	1.1
Toyota	Celica		1971	1976	4	1.6L	2T		43XLS	AC4		0.8
Toyota	Celica		1975	1981	4	2.0L	18RC		43XLS	AC4		0.8
Toyota	Celica		1981	1985	4	2.0L	21RC		43XLS	AC4		0.8
Toyota	Celica		1983	1985	4	2.0L	2SC		43XLS	AC4		0.8

MAKE	MODEL	SERIES / BADGE	FROM	TO	CYLS	CAPACITY	ENGINE	ADDITIONAL INFORMATION	REGULAR	PLATINUM (RAPIDFIRE®)	DOUBLE PLATINUM	GAP (MM)#
Toyota	Celica		1984	09/86	4	2.4L	22REC		R43XLS	AC4		0.8
Toyota	Celica	ST162	1985	1989	4	2.0L	3SFE				41825	1.1
Toyota	Celica	ST162	1985	1989	4	2.0L	3SGE				41825	1.1
Toyota	Celica	ST185	1989	1993	4	2.0L	3SGTE	Turbo	41602		41970*	0.8
Toyota	Celica	ST184	12/89	1994	4	2.2L	5SFE		FR3LS		41800	1.1
Toyota	Celica	ST205	1994	1999	4	2.0L	3SGTE	Turbo	41602		41970*	0.8
Toyota	Celica	ST204	03/94	1999	4	2.2L	5SFE		41602	AC5	41801	1.1
Toyota	Celica	ZZT231	11/99	2005	4	1.8L	2ZZGE		41602	AC5	41966*	1.1
Toyota	Celsior	UCF20R	1994	2000	8	4.0L	1UZFE				41966*	1.1
Toyota	Celsior	UCF31R	2000	2006	8	4.3L	3UZFE				41966*	1.1
Toyota	Coaster	RU	1968	1980	4	2.0L	5R		R43XLS	AC4		0.8
Toyota	Coaster	RB	1979	1982	4	2.2L	20R		R43XLS	AC4		0.8
Toyota	Coaster	RB	1980	1987	4	2.4L	22R		R43XLS	AC4		0.8
Toyota	Corolla		08/69	03/70	4	1.2L	3K		43XLS	AC4		0.8
Toyota	Corolla		03/70	11/78	4	1.2L	3KH		43XLS	AC4		0.8
Toyota	Corolla		08/74	08/79	4	1.2L	3KC		43XLS	AC4		0.8
Toyota	Corolla		11/78	1987	4	1.3L	4KC		43XLS	AC4		0.8
Toyota	Corolla		1983	1987	4	1.6L	4AC			AC4		1.1
Toyota	Corolla		1985	1989	4	1.6L	4AL			AC4		1.1
Toyota	Corolla	AE82	01/86	1989	4	1.6L	4AGE	DOHC			41825	1.1
Toyota	Corolla	AE95	04/88	1995	4	1.6L	4AFE		FR3LS		41969*	0.8
Toyota	Corolla	AE90	06/89	1992	4	1.4L	6AFC				41806	1.1
Toyota	Corolla	AE92	06/89	1994	4	1.6L	4AGE		41602		41970*	0.8
Toyota	Corolla	AE94	07/91	09/94	4	1.6L	4AFE		41629		41969*	0.8
Toyota	Corolla	AE96	1992	1994	4	1.8L	7AFE		41629		41969*	0.8
Toyota	Corolla	AE93	10/92	1994	4	1.8L	7AFE		41629		41969*	0.8
Toyota	Corolla	AE101	09/94	1999	4	1.6L	4AFE		FR3LS		41969*	0.8
Toyota	Corolla	AE102	09/94	1999	4	1.8L	7AFE		41629		41969*	0.8
Toyota	Corolla	AE112	10/99	2001	4	1.8L	7AFE		41629		41969*	0.8
Toyota	Corolla	AE112	04/01	11/01	4	1.8L	7AFET	Turbo	41602		41970*	0.8
Toyota	Corolla	NZE121R Runx	01/00	09/06	4	1.5L	1NZFE				41835*	1.1
Toyota	Corolla	NZE121R Fielder	05/04	09/06	4	1.5L	1NZFE	Auto Wagon			41835*	1.1
Toyota	Corolla	NZE121R	05/04	09/06	4	1.5L	1NZFE	sEDAN			41835*	1.1
Toyota	Corolla	ZZE122R	12/01	2007	4	1.8L	1ZZFE		41629		41800	1.1
Toyota	Corolla	ZZE123R	2001	2006	4	1.8L	2ZZGE				41966*	1.1
Toyota	Corolla	ZZE123R Sportivo	05/03	2005	4	1.8L	2ZZGE		41602	AC5	41966*	1.1
Toyota	Corolla	ZRE152R	05/07	2014	4	1.8L	2ZRFE				41964*	1.1
Toyota	Corolla	ZRE152R Ascent	05/07	2014	4	1.8L	2ZRFE				41964*	1.1
Toyota	Corolla	ZRE153R Ultima	06/10	2014	4	2.0L	3ZRFAE				41964*	1.1
Toyota	Corolla	ZRE182R	10/12	on	4	1.8L	2ZRFE				41964*	1.1
Toyota	Corona		11/64	1971	4	1.5L	2R		42XLS			0.8
Toyota	Corona	MK11	1967	1971	4	1.5L	2R		R43XLS	AC4		0.8
Toyota	Corona		1970	1974	4	1.6L	12R		42XLS			0.8
Toyota	Corona	MX10 MK11	1972	1974	4	2.0L	M		R43XLS	AC4		0.8
Toyota	Corona	MX22 MK11	1972	1974	4	2.3L	2M		R43XLS	AC4		0.8

MAKE	MODEL	SERIES / BADGE	FROM	TO	CYLS	CAPACITY	ENGINE	ADDITIONAL INFORMATION	REGULAR	PLATINUM (RAPIDFIRE®)	DOUBLE PLATINUM	GAP (MM)#
Toyota	Corona	MX13 MK11	1974	1977	4	2.6L	4M		R43XLS	AC4		0.8
Toyota	Corona	MX23 MK11	1974	1977	4	2.6L	4M		R43XLS	AC4		0.8
Toyota	Corona	RT104	1974	1979	4	2.0L	18R		R43XLS	AC4		0.8
Toyota	Corona	RT118	1974	1979	4	2.0L	18R		R43XLS	AC4		0.8
Toyota	Corona	RT132	1979	1982	4	2.0L	18RC		R43XLS	AC4		0.8
Toyota	Corona	RT133	1982	1984	4	2.0L	21RC		R43XLS	AC4		0.8
Toyota	Corona	ST141	08/83	04/87	4	2.0L	2SC		R43XLS	AC4		0.8
Toyota	Corona	RT142	1994	1987	4	2.4L	22RE		R43XLS	AC4		0.8
Toyota	Cressida	MX32	1977	1981	4	2.6L	4M		R43XLS	AC4		0.8
Toyota	Cressida	MX36	1977	1981	4	2.6L	4M		R43XLS	AC4		0.8
Toyota	Cressida	MX62	1981	1984	6	2.8L	5ME		R43XLS	AC4		0.8
Toyota	Cressida	MX73	1984	1988	6	2.8L	5ME		R43XLS	AC4		0.8
Toyota	Cressida	MX73	11/85	1988	6	2.8L	5MGE	DOHC	R43XLS	AC4	41802	1.1
Toyota	Cressida	MX83	10/88	1992	6	3.0L	7MGE				41825	1.1
Toyota	Crown		1966	1969	6	2.0L	M		43XLS	AC4		0.8
Toyota	Crown		1967	1971	6	2.3L	2M		43XLS	AC4		0.8
Toyota	Crown		1968	1971	4	2.0L	5R		43XLS	AC4		0.8
Toyota	Crown		1971	1975	6	2.6L	4M		43XLS	AC4		0.8
Toyota	Crown	MS123	10/83	1985	6	2.8L	5ME		R43XLS	AC4		0.8
Toyota	Crown	MX125	12/85	1988	6	2.8L	5MGE		R43XLS	AC4	41802	1.1
Toyota	Crown	UZS171R	1999	2004	8	4.0L	1UZFE				41966*	1.1
Toyota	Dyna	RU10	1969	1977	4	2.0L	5R		R43XLS	AC4		0.8
Toyota	Dyna	RU20	1977	1984	4	2.0L	5R		R43XLS	AC4		0.8
Toyota	Dyna	RU15	1979	1984	4	2.0L	5R		R43XLS	AC4		0.8
Toyota	Dyna 100	YH81	11/85	1995	4	1.8L	2Y		R43XLS	AC4		0.8
Toyota	Dyna 100	YY100	12/94	2001	4	1.8L	2Y		R43XLS	AC4		0.8
Toyota	Dyna 200	YU60	11/84	1994	4	2.0L	3Y	CARB	R43XLS	AC4		0.8
Toyota	Dyna 200	YU62	11/86	07/91	4	2.3L	4Y	CARB	R43XLS	AC4		0.8
Toyota	Echo	NCP10	09/99	2005	4	1.3L	2NZFE		FR3LS		41800	1.1
Toyota	Echo	NCP13	09/99	2005	4	1.5L	1NZFE		FR3LS		41800	1.1
Toyota	Echo	NCP12	02/00	2005	4	1.5L	1NZFE		FR3LS		41969*	0.8
Toyota	Estima	ACR50R	2006	2018	4	2.4L	2AZFE				41966*	1.1
Toyota	Estima	ACR55R	2006	2018	4	2.4L	2AZFE				41966*	1.1
Toyota	Estima	GSR50R	01/06	on	6	3.5L	2GRFE	Wagon			41835*	1.1
Toyota	Estima	GSR55R	01/06	on	6	3.5L	2GRFE	Wagon			41835*	1.1
Toyota	Estima	MCR30R	2000	2005	6	3.0L	1MZFE				41966*	1.1
Toyota	Estima	MCR40R	2000	2005	6	3.0L	1MZFE				41966*	1.1
Toyota	Estima Hybrid	AHR10R	2001	2006	4	2.4L	2AZFXE				41966*	1.1
Toyota	Estima Hybrid	AHR20R	2006	2011	4	2.4L	2AZFXE				41966*	1.1
Toyota	FJ Cruiser	GSJ15R	03/11	on	6	4.0L	GRFE				41835*	1.1
Toyota	Harrier	MCU10	1997	2003	6	3.0L	1MZFE				41966*	1.1
Toyota	Harrier	MCU15R	1997	2003	6	3.0L	1MZFE				41966*	1.1
Toyota	Harrier	MCU36R	2003	2006	6	3.0L	1MZFE				41966*	1.1
Toyota	Harrier	MCU38R	2005	2018	6	3.3L	3MZFE				41966*	1.1
Toyota	Harrier 240G	ACU30R	2003	2018	4	2.4L	2AZFE				41966*	1.1
Toyota	Harrier 240G	ACU35R	2003	2018	4	2.4L	2AZFE				41966*	1.1

MAKE	MODEL	SERIES / BADGE	FROM	TO	CYLS	CAPACITY	ENGINE	ADDITIONAL INFORMATION	REGULAR	PLATINUM (RAPIDFIRE®)	DOUBLE PLATINUM	GAP (MM)#
Toyota	Harrier 300G	MCU30R	2003	2006	6	3.0L	1MZFE				41966*	1.1
Toyota	Harrier 300G	MCU35R	2003	2006	6	3.0L	1MZFE				41966*	1.1
Toyota	Hi-Ace	RH	1970	1985	4	1.6L	12R		R43XLS	AC4		0.8
Toyota	Hi-Ace	RH	1977	1983	4	2.0L	18R		R43XLS	AC4		0.8
Toyota	Hi-Ace		1982	08/89	4	2.0L	3Y		43XLS	AC4		0.8
Toyota	Hi-Ace		12/82	08/86	4	1.8L	2YC		43XLS	AC4		0.8
Toyota	Hi-Ace		1985	1989	4	2.2L	4Y		43XLS	AC4		0.8
Toyota	Hi-Ace	RZH103	1989	05/94	4	2.4L	2RZE		R43XLS	AC4	41802	1.1
Toyota	Hi-Ace	RZH113	1989	1998	4	2.4L	2RZ	CARB	R43XLS	AC4	41802	1.1
Toyota	Hi-Ace	RZH103	10/89	09/98	4	2.4L	2RZ	CARB	R43XLS	AC4	41802	1.1
Toyota	Hi-Ace	RZH125	10/89	09/99	4	2.4L	2RZ	CARB	R43XLS	AC4	41802	1.1
Toyota	Hi-Ace	RZH113	1998	2005	4	2.4L	2RZE		R43XLS	AC4	41802	1.1
Toyota	Hi-Ace	RZH125	02/98	02/05	4	2.4L	2RZE		R43XLS	AC4	41802	1.1
Toyota	Hi-Ace	TRH201R	03/05	on	4	2.7L	2TRFE				41835*	1.1
Toyota	Hi-Ace	TRH221R	03/05	on	4	2.7L	2TRFE				41835*	1.1
Toyota	Hi-Ace	TRH223R	03/05	on	4	2.7L	2TRFE				41835*	1.1
Toyota	Hi-Ace Regius	RCH41R	1997	1999	4	2.7L	3RZFE				41966*	1.1
Toyota	Hi-Ace Regius	RCH47R	1997	1999	4	2.7L	3RZFE				41966*	1.1
Toyota	Highlander	MCU28R	2003	2007	6	3.3L	3MZFE				41966*	1.1
Toyota	Hi-Lux	RN	1970	1972	4	1.6L	12R		R43XLS	AC4		0.8
Toyota	Hi-Lux	RN	1978	1983	4	1.8L	18R		R43XLS	AC4		0.8
Toyota	Hi-Lux		11/83	1988	4	2.0L	3Y		43XLS	AC4		0.8
Toyota	Hi-Lux	YN55R	11/83	09/87	4	1.6L	1YC		43XLS	AC4		0.8
Toyota	Hi-Lux	YN56R	1984	1988	4	1.8L	2YC		43XLS	AC4		0.8
Toyota	Hi-Lux		11/85	1992	4	2.2L	4Y		43XLS	AC4		0.8
Toyota	Hi-Lux	RN	10/88	1997	4	2.4L	22R		R43XLS	AC4	41802	0.9
Toyota	Hi-Lux	VZN130 - Surf	08/90	11/95	6	3.0L	3VZE		41629			0.8
Toyota	Hi-Lux	RZN147	10/97	2002	4	2.0L	1ZRFE		R43XLS	AC4		0.8
Toyota	Hi-Lux	RZN149	11/97	04/05	4	2.7L	3RZFE		41629		41969*	0.8
Toyota	Hi-Lux	RZN169	11/97	10/02	4	2.7L	3RZFE		41629		41969*	0.8
Toyota	Hi-Lux	RZN154	1998	04/05	4	2.7L	3RZFE		41629		41969*	0.8
Toyota	Hi-Lux	RZN174	01/98	10/02	4	2.7L	3RZFE		41629		41969*	0.8
Toyota	Hi-Lux	VZN167	11/02	2005	6	3.4L	5VZFE		41629		41969*	0.8
Toyota	Hi-Lux	GGN15	2005	on	6	4.0L	1GRFE				41835*	1.1
Toyota	Hi-Lux	TGN16	2005	on	4	2.7L	2TRFE				41835*	1.1
Toyota	Hi-Lux	GG-N25R	03/05	on	6	4.0L	1GRFE	175kW			41835*	1.1
Toyota	Kluger	MCU25R	2000	2007	6	3.0L	1MZFE		41602	AC5	41966*	1.1
Toyota	Kluger	MCU28	10/03	2007	6	3.3L	3MZFE		41602	AC5	41966*	1.1
Toyota	Kluger	GSU40R	08/07	02/14	6	3.5L	2GRFE				41835*	1.1
Toyota	Kluger	GSU45R	08/07	02/14	6	3.5L	2GRFE				41835*	1.1
Toyota	Kluger Grande	GSU50R	03/14	02/17	6	3.5L	2GRFE				41835*	1.1
Toyota	Kluger Grande	GSU55R	03/14	02/17	6	3.5L	2GRFE				41835*	1.1
Toyota	Kluger GX GXL	GSU55R	03/14	02/17	6	3.5L	2GRFE				41835*	1.1
Toyota	Kluger GX GXL	GSU55R	03/14	02/17	6	3.5L	2GRFE				41835*	1.1
Toyota	Landcruiser	FJ40	1965	1974	6	3.9L	F		R43XLS	AC4		0.8
Toyota	Landcruiser	FJ45	1965	1974	6	3.9L	F		R43XLS	AC4		0.8
Toyota	Landcruiser	FJ55	1965	1972	6	3.9L	F		R43XLS	AC4		0.8

MAKE	MODEL	SERIES / BADGE	FROM	TO	CYLS	CAPACITY	ENGINE	ADDITIONAL INFORMATION	REGULAR	PLATINUM (RAPIDFIRE®)	DOUBLE PLATINUM	GAP (MM)#
Toyota	Landcruiser	FJ70	1985	09/92	6	4.0L	3F	CARB	R43XLS	AC4		0.8
Toyota	Landcruiser	FJ73	1985	1991	6	4.0L	3F	CARB	R43XLS	AC4		0.8
Toyota	Landcruiser	FJ75	1985	1993	6	4.0L	3F	CARB	R43XLS	AC4		0.8
Toyota	Landcruiser	FJ80	1990	1992	6	4.0L	3F	CARB	R43XLS	AC4		0.8
Toyota	Landcruiser	FJ80	05/90	1992	6	4.0L	3FE	EFI	R43XLS	AC4	41802	1.1
Toyota	Landcruiser	FZJ75	11/92	11/99	6	4.5L	1FZFE		41629		41969*	0.8
Toyota	Landcruiser	FZJ80	11/92	02/98	6	4.5L	1FZFE		41629		41969*	0.8
Toyota	Landcruiser	FJ62	03/94	04/90	6	4.0L	3F	CARB	R43XLS	AC4		0.8
Toyota	Landcruiser	FZJ105	03/98	2003	6	4.5L	1FZFE		41629		41800	1.1
Toyota	Landcruiser	UZJ100	06/98	2007	8	4.7L	2UZFE		41602	AC5	41966*	1.1
Toyota	Landcruiser	FZJ78	10/99	07/01	6	4.5L	1FZFE		41629		41800	1.1
Toyota	Landcruiser	FZJ79	10/99	02/07	6	4.5L	1FZFE		41629		41800	1.1
Toyota	Landcruiser	UZJ200R	2007	04/12	8	4.7L	2UZFE		41602		41966*	1.1
Toyota	Lexcen	VN	09/89	1991	6	3.8L			R44LTS6		41976*	1.5
Toyota	Lexcen	VP	1991	1993	6	3.8L	L27		R44LTS6		41976*	1.5
Toyota	Lexcen	VR	1993	1995	6	3.8L	L27		R44LTS6		41976*	1.5
Toyota	Lexcen	VS	1995	1997	6	3.8L	L27		R44LTS6		41976*	1.5
Toyota	Liteace	KM20	02/80	1985	4	1.3L	4K		R43XLS	AC4		0.8
Toyota	Liteace	YM21	1983	1986	4	1.8L	2Y		R43XLS	AC4		0.8
Toyota	Liteace	KM36	1985	1992	4	1.5L	5K		R43XLS	AC4		0.8
Toyota	Liteace	YM30	1985	1992	4	1.8L	2Y		R43XLS	AC4		0.8
Toyota	Liteace	YM35	1985	1992	4	1.8L	2Y		R43XLS	AC4		0.8
Toyota	Liteace	YM40	10/85	01/92	4	2.0L	3Y		R43XLS	AC4	41802	1.1
Toyota	Liteace	YM41	03/86	1989	4	2.0L	3Y		R43XLS	AC4	41802	1.1
Toyota	MR2	AW11	11/87	1990	4	1.6L	4AGEL				41825	1.1
Toyota	MR2	SW20	03/90	2000	4	2.0L	3SGE		41602		41970*	0.8
Toyota	MR2	ZZW30	10/00	2002	4	1.8L	1ZZFE		41629		41800	1.1
Toyota	MR2	ZZW30 Series II	11/02	2005	4	1.8L	1ZZFE		41629		41800	1.1
Toyota	Paseo	EL44	07/91	1996	4	1.5L	5EFE		FR3LS		41800	1.1
Toyota	Paseo	EL54	1995	1999	4	1.5L	5EFE		FR3LS		41800	1.1
Toyota	Prado	RZJ95	07/96	05/02	4	2.7L	3RZFE		41629		41969*	0.8
Toyota	Prado	VZJ95	07/96	2003	6	3.4L	SVZFE		41629		41800	1.1
Toyota	Prado	GRJ120R	03/03	10/09	6	4.0L	1GRFE				41835*	1.1
Toyota	Prado	RZJ120	03/03	08/04	4	2.7L	3RZFE		41629		41969*	0.8
Toyota	Prius	NHW11	10/01	2003	4	1.5L	1NZFXE		41629		41800	1.1
Toyota	Prius	NHW20R	2003	2009	4	1.5L	1NZFXE				41800	1.1
Toyota	Previa	GSR50R	2007	2008	6	3.5L	2GRFE				41835*	1.1
Toyota	Prius	ZVW30R - Hybrid	07/09	2014	4	1.8L	2ZRFXE				41964*	1.1
Toyota	Prius	ZVW40R - V Hybrid, V Tech	05/12	2014	4	1.8L	2ZRFXE				41964*	1.1
Toyota	RAV4	SXA10	05/94	04/00	4	2.0L	3SFE		41602	AC5	41801	1.1
Toyota	RAV4	ACA20	07/00	03/03	4	2.0L	1AZFE		41602	AC5	41966*	1.1
Toyota	RAV4	ACA21	07/00	09/03	4	2.0L	1AZFE		41602	AC5	41966*	1.1
Toyota	RAV4	ACA22	10/03	01/06	4	2.4L	2AZFE		41602	AC5	41966*	1.1
Toyota	RAV4	ACA23	10/03	01/06	4	2.4L	2AZFE		41602	AC5	41966*	1.1
Toyota	RAV4	ACA31R	2005	2018	4	2.4L	2AZFE				41966*	1.1
Toyota	RAV4	ACA33R	2006	01/13	4	2.4L	2AZFE		41602		41966*	1.1

MAKE	MODEL	SERIES / BADGE	FROM	TO	CYLS	CAPACITY	ENGINE	ADDITIONAL INFORMATION	REGULAR	PLATINUM (RAPIDFIRE®)	DOUBLE PLATINUM	GAP (MM)#
Toyota	RAV4	ACA38L	2005	2013	4	2.4L	2AZFE				41966*	1.1
Toyota	RAV4	ACA38R	2010	2013	4	2.4L	2AZFE				41966*	1.1
Toyota	RAV4	GSA33R	2007	01/13	6	3.5L	2GRFE				41835*	1.1
Toyota	RAV4	ASA44R	02/13	on	4	2.5L	2ARFE				41835*	1.1
Toyota	RAV4	ZSA42R	02/13	on	4	2.0L	3ZRFE	DOHC VVT			41964*	1.1
Toyota	Rukus	AZE151R	2010	on	4	2.4L	2AZFE		41602		41966*	1.1
Toyota	Spacia	YR22	10/93	1998	4	2.2L	4YE	EFI	R43XLS	AC4	41802	1.1
Toyota	Spacia	SR40	01/98	2002	4	2.0L	3SFE		41602	AC5	41801	1.1
Toyota	Sprinter	AE86	1983	1985	4	1.6L	4AC		R43XLS	AC4		0.8
Toyota	Sprinter	AE102	1994	2007	4	1.8L	7AFE		41629		41969*	0.8
Toyota	Soarer	UZZ40R	2001	2010	8	4.3L	3UZFE				41966*	1.1
Toyota	Starlet	EP9	04/96	1999	4	1.3L	4EFE		41629		41969*	0.8
Toyota	Stout		1968	1979	4	2.0L	5R		43XLS	AC4		0.8
Toyota	Supra	MA61	10/83	1986	6	2.8L	5ME		R42XLS	AC4	41804	0.8
Toyota	Supra	MA70	03/86	1993	6	3.0L	7MGE				41825	1.1
Toyota	T18	TE72	11/79	1985	4	1.8L	3TC		R43XLS	AC4		0.8
Toyota	Tarago	YR20	1983	1984	4	1.8L	2YC		43XLS	AC4		0.8
Toyota	Tarago	YR21	1984	1990	4	2.0L	3YC		43XLS	AC4		0.8
Toyota	Tarago	YR22	10/85	09/90	4	2.2L	4YE	EFI	R43XLS	AC4	41802	1.1
Toyota	Tarago	TCR10	09/90	08/00	4	2.4L	2TZFE		FR3LS		41800	1.1
Toyota	Tarago	TCR11	09/90	08/00	4	2.4L	2TZFE		FR3LS		41800	1.1
Toyota	Tarago	TCR20	09/90	10/91	4	2.4L	2TZFE		FR3LS		41800	1.1
Toyota	Tarago	TCR21	09/90	10/93	4	2.4L	2TZFE		FR3LS		41800	1.1
Toyota	Tarago	YR31	03/96	10/90	4	2.2L	4YE	EFI	R43XLS	AC4	41802	1.1
Toyota	Tarago	ACR30R	06/00	2003	4	2.4L	2AZFE		41602	AC5	41966*	1.1
Toyota	Tarago	ACR30R Series II	06/03	2006	4	2.4L	2AZFE		41602	AC5	41966*	1.1
Toyota	Tarago	ACR50R	2006	on	4	2.4L	2AZFE		41602		41966*	1.1
Toyota	Tarago	GSR50R	2007	on	6	3.5L	2GRFE				41835*	1.1
Toyota	Tercel	AL25	10/83	1988	4	1.5L	3AC		R43XLS	AC4		0.8
Toyota	Town Ace	YR39	04/92	1996	4	2.0L	3Y		R43XLS	AC4	41802	1.1
Toyota	Town Ace	KR42	01/97	1998	4	1.8L	7K	CARB	R43XLS	AC4		0.8
Toyota	Town Ace	KR42	12/98	2003	4	1.8L	7KE	EFI	R43XLS	AC4	41802	1.1
Toyota	Toyo-Ace	RY31	1980	1985	4	2.0L	5R		43XLS	AC4		0.8
Toyota	Vienta	VCV10	10/95	08/97	6	3.0L	3VZFE				41825	1.1
Toyota	Vienta	MCV20	08/97	10/00	6	3.0L	1MZFE				41801	1.1
Toyota	Voltz	ZZE136R	2002	2004	4	1.8L	1ZZFE				41966*	1.1
Toyota	Voltz	ZZE137R	2002	2004	4	1.8L	2ZZGE				41966*	1.1
Toyota	Windom	MCV30R	2001	2006	6	3.0L	1MZFE				41966*	1.1
Toyota	Yaris		10/05	on	4	1.3L	2NZFE		41629		41800	1.1
Toyota	Yaris		10/05	on	4	1.5L	1NZFE		41629		41800	1.1
TRIUMPH												
Triumph	2000	MK 1	1965	1970	6	2.0L			R42XLS	AC4	41804	0.8
Triumph	2000	MK 11	1970	1979	6	2.0L			R42XLS	AC4	41804	0.8
Triumph	2500		1973	1978	6	2.5L			R43XLS	AC4		0.8
Triumph	2.5 PI		1969	1975	6	2.5L			R42XLS	AC4	41804	0.8
Triumph	2.5 PI	MK 1	1969	1970	6	2.0L			R42XLS	AC4	41804	0.8
Triumph	2.5 PI	MK 11	1970	1975	6	2.0L			R42XLS	AC4	41804	0.8
Triumph	Dolomite		1974	1980	4	1.9L			R42XLS	AC4	41804	0.8

MAKE	MODEL	SERIES / BADGE	FROM	TO	CYLS	CAPACITY	ENGINE	ADDITIONAL INFORMATION	REGULAR	PLATINUM (RAPIDFIRE®)	DOUBLE PLATINUM	GAP (MM)#
Triumph	Herald		1967	1971	4	1.2L			R42XLS	AC4	41804	0.8
Triumph	Spitfire	MK III	1968	1972	4	1.3L			R42XLS	AC4	41804	0.8
Triumph	Spitfire	MK IV	1968	1972	4	1.3L			R42XLS	AC4	41804	0.8
Triumph	Stag		1970	1977	8	3.0L			R43XLS	AC4		0.8
Triumph	TR5		1968	1968	6	2.5L			R42XLS	AC4	41804	0.8
Triumph	TR6		1969	1975	6	2.5L			R42XLS	AC4	41804	0.8
Triumph	TR7		1975	1981	4	2.0L			R43XLS	AC4		0.8
VOLKSWAGEN												
Volkswagen	Bora		11/99	2005	4	2.0L	APK	SOHC	41602	AC5	41801	1.0
Volkswagen	Bora		11/99	2001	5	2.3L	AGZ	SOHC 110kW	41629		41800	1.0
Volkswagen	Bora	4Motion	2001	2003	6	2.8L	AUE				41806	1.1
Volkswagen	Bora		07/01	2005	5	2.3L	AQN				41806	1.1
Volkswagen	Caddy		02/05	2010	4	1.6L	BGU		41602	AC5	41801	1.0
Volkswagen	Caravelle		05/92	2005	5	2.5L	AET		R43XLS	AC4		0.8
Volkswagen	Caravelle		11/02	09/05	6	2.8L	AMV				41806	1.1
Volkswagen	EOS	1F	2007	2010	4	2.0L	BWA	Turbo	41602		41801	1.0
Volkswagen	EOS	1F	2010	on	4	2.0L	CCZB	Turbo	41602		41801	1.0
Volkswagen	Golf	TYPE 5	2005	02/09	4	1.6L	BSE		41602			1.0
Volkswagen	Golf Generation I		03/76	1980	4	1.6L	FN		R42XLS	AC4	41804	0.8
Volkswagen	Golf Generation I	GLS	1979	1980	4			110HP	R42XLS	AC4	41804	0.8
Volkswagen	Golf Generation II	GTi	09/90	1993	4	1.8L	RV	SOHC	R42XLS	AC4	41804	0.8
Volkswagen	Golf Generation III		1992	1996	4	2.0L	2E	SOHC	R42XLS	AC4	41804	0.8
Volkswagen	Golf Generation III	VR6	03/94	06/95	6	1.8L	AAA	SOHC			41982*	0.7
Volkswagen	Golf Generation III		08/94	09/98	4	2.0L	ADY	SOHC	R42XLS	AC4	41804	0.8
Volkswagen	Golf Generation III	Cabriolet	10/95	09/98	4	2.0L	ADY	SOHC	R42XLS	AC4	41804	0.8
Volkswagen	Golf Generation III	CL Hatch	10/95	09/98	4	1.8L	ADZ	SOHC	R42XLS	AC4	41804	0.8
Volkswagen	Golf Generation IV		1998	2004	4	2.0L	AGY	SOHC	41602	AC5	41801	1.1
Volkswagen	Golf Generation IV	Cabriolet CL	09/98	2000	4	1.8L	AGN	SOHC	41602	AC5	41801	1.0
Volkswagen	Golf Generation IV	Cabriolet GL	09/98	2003	4	2.0L	AGG	SOHC			41970*	0.7
Volkswagen	Golf Generation IV	GLE	09/98	1999	4	1.8L	AGN	DOHC	41602	AC5	41801	1.0
Volkswagen	Golf Generation IV		10/98	06/99	4	2.0L	AGN	SOHC	41602	AC5	41801	1.1
Volkswagen	Golf Generation IV	GL	10/98	02/02	4	1.6L	AEH	DOHC	41602	AC5	41801	1.0
Volkswagen	Golf Generation IV	GL	10/98	02/02	4	1.6L	AKL	DOHC	41602	AC5	41801	1.0
Volkswagen	Golf Generation IV	GTi	03/99	2004	4	1.8L	AGU	Turbo DOHC	41602		41970*	0.8
Volkswagen	Golf Generation IV		06/99	2002	4	1.6L	AKL		41602	AC5	41801	1.0
Volkswagen	Golf Generation IV	GLE	07/99	2002	4	2.0L	AGG	SOHC	R42XLS	AC4	41804	0.8
Volkswagen	Golf Generation IV	GLE	07/99	2002	4	2.0L	APK	SOHC	41602	AC5	41801	1.0
Volkswagen	Golf Generation IV		03/02	05/03	4	1.6L	AVU	DOHC	41602	AC5	41801	1.0
Volkswagen	Golf Generation IV		06/03	07/04	4	1.6L	BFQ	DOHC	41602	AC5	41801	1.0
Volkswagen	Golf Generation V		08/04	2008	4	1.6L	BGU	DOHC	41602	AC5	41801	1.0
Volkswagen	Golf Generation V		08/04	2009	4	2.0L	BLX		41602	AC5	41801	1.1
Volkswagen	Golf Generation V		2005	2009	4	2.0L	AXX	Turbo	41602		41801	1.0
Volkswagen	Golf Generation VI		03/09	01/14	4	1.4L	CAXA				41982*	0.8
Volkswagen	Golf Generation VI		10/10	ON	4	1.2L	CBZB				41982*	0.7
Volkswagen	Jetta	1KM	2006	2008	4	2.0L	BLR				41806	1.0
Volkswagen	Jetta	1KM	2006	10/09	4	2.0L	BWA	Turbo	41602		41801	1.0
Volkswagen	New Beetle		01/00	2002	4	2.0L	AQY		41602	AC5	41801	1.0
Volkswagen	New Beetle		09/01	2004	4	1.8L	AVU	Turbo	41602		41970*	0.8

MAKE	MODEL	SERIES / BADGE	FROM	TO	CYLS	CAPACITY	ENGINE	ADDITIONAL INFORMATION	REGULAR	PLATINUM (RAPIDFIRE®)	DOUBLE PLATINUM	GAP (MM)#
Volkswagen	New Beetle		01/02	2003	4	1.6L	AYD	SOHC	41602	AC5	41801	1.0
Volkswagen	New Beetle		01/02	2002	4	2.0L	AQY		41602	AC5	41801	1.1
Volkswagen	New Beetle	9C - 1.6	01/02	10/11	4	1.6L	BFS		41602			1.0
Volkswagen	Passat		11/75	1981	4	1.6L	FS		R42XLS	AC4	41804	0.8
Volkswagen	Passat		1994	1995	4	2.0L	2E	SOHC	R42XLS	AC4	41804	0.8
Volkswagen	Passat	VR6	07/94	06/95	6	2.8L	AAA	SOHC			41982*	0.7
Volkswagen	Passat		08/95	12/96	4	2.0L	ADY	SOHC	R42XLS	AC4	41804	0.8
Volkswagen	Passat		1997	12/00	4	1.8L	AEB	Turbo	41602		41970*	0.8
Volkswagen	Passat		02/98	2000	4	1.8L	ADR	DOHC	41602		41970*	0.8
Volkswagen	Passat		02/98	2001	6	2.8L	ACK	DOHC			41970*	0.7
Volkswagen	Passat		02/98	2001	6	2.8L	AGE	DOHC	41602	AC5	41801	1.0
Volkswagen	Passat	3B - 4Motion Variant	1999	2001	6	2.8L	APR		41602			0.8
Volkswagen	Passat	3B - 2.8 V6 Syn- cro, V6 4Motion	03/99	04/01	6	2.8L	APR		41602			0.8
Volkswagen	Passat	3B - 2.8 V6	07/99	04/01	6	2.8L	APR		41602			0.8
Volkswagen	Passat	4Motion	08/00	2004	6	2.8L	BBG	DOHC	41602		41970*	0.8
Volkswagen	Passat		2001	11/05	5	2.3L	AZX	SOHC			41806	1.1
Volkswagen	Passat		05/01	10/02	4	1.8L	AWT	Turbo	41602		41970*	0.8
Volkswagen	Passat		05/01	2002	6	2.8L	BBG	DOHC	41602		41970*	0.8
Volkswagen	Passat		11/02	2005	6	2.8L	BBG	DOHC	41629		41800	1.1
Volkswagen	Polo		10/96	10/00	4	1.6L	AEE	SOHC	R42XLS	AC4	41804	0.8
Volkswagen	Polo		09/00	2002	4	1.4L	AHW	DOHC	41602	AC5	41801	1.0
Volkswagen	Polo		07/02	2008	4	1.4L	BBY	Manual DOHC	41602	AC5	41801	1.0
Volkswagen	Polo		07/02	2008	4	1.4L	BBY	Auto DOHC			41967*	1.0
Volkswagen	Polo		09/03	07/07	4	1.4L	BBZ	DOHC	41629		41800	1.0
Volkswagen	Polo	9N - GTI	11/05	08/10	4	1.8L	BJX	Turbo			41970*	0.8
Volkswagen	Polo	6R	05/10	07/14	4	1.2L	CBZB	Turbo			41982*	0.7
Volkswagen	Tiguan	5N	05/08	08/10	4	2.0L	CAWA	Turbo	41602		41801	1.1
Volkswagen	Tiguan	5N	05/08	09/11	4	2.0L	CAWB	Turbo	41602		41801	1.1
Volkswagen	Tiguan	5N	10/11	09/16	4	2.0L	CCZD				41966*	1.0
Volkswagen	Touareg		09/03	2006	8	4.2L	AXQ	DOHC	41629		41969*	0.8
Volkswagen	Touareg	7L	2007	2008	8	4.2L	BAR				41966*	0.9
Volkswagen	Transporter	T4	01/92	1996	5	2.5L	ACU	SOHC	R43XLS	AC4		0.8
Volkswagen	Transporter	T4	11/92	2004	4	2.0L	AAC	SOHC	R43XLS	AC4		0.8
Volkswagen	Transporter	T4	05/95	2004	5	2.5L	ACU	Syncro SOHC	R43XLS	AC4		0.8
Volkswagen	Transporter	T4	11/97	2004	5	2.5L	AET	SOHC	R43XLS	AC4		0.8
Volkswagen	Transporter	T4	11/02	2004	6	2.8L	AMV				41806	1.1
Volkswagen	Transporter	T5	08/04	2010	4	2.0L	AXA		41602	AC5	41801	1.0
Volkswagen	Vento		1992	1996	4	2.0L	2E	SOHC	R42XLS	AC4	41804	0.8
Volkswagen	Vento		06/95	1997	4	2.0L	ADY	SOHC	R42XLS	AC4	41804	0.8
VOLVO												
Volvo	240		1981	1985	4	2.3L	B23E		R43XLS	AC4		0.8
Volvo	240		1983	1984	4	2.1L	B21A		R42XLS	AC4	41804	0.8
Volvo	240		1986	1993	4	2.3L	B230F		R43XLS	AC4		0.8
Volvo	360		03/84	1987	4	2.0L	B19E		R42XLS	AC4	41804	0.8
Volvo	360		03/84	1990	4	2.0L	B200E		R42XLS	AC4	41804	0.8

MAKE	MODEL	SERIES / BADGE	FROM	TO	CYLS	CAPACITY	ENGINE	ADDITIONAL INFORMATION	REGULAR	PLATINUM (RAPIDFIRE®)	DOUBLE PLATINUM	GAP (MM)#
Volvo	440		10/93	1996	4	2.0L	B20F		R42XLS	AC4	41804	0.8
Volvo	740		1985	1990	4	2.3L	B230FT		R43XLS	AC4		0.8
Volvo	740		06/85	1992	4	2.3L	B230E		R43XLS	AC4		0.8
Volvo	740		1986	1991	4	2.3L	B230F		R43XLS	AC4		0.8
Volvo	850		05/96	1997	5	2.3L	B5234FT	T5 Turbo	41602		41970*	0.8
Volvo	940		1990	1998	4	2.3L	B230FT	Turbo	R43XLS	AC4		0.8
Volvo	940		1991	1995	4	2.3L	B230FB		R43XLS	AC4		0.8
Volvo	960		11/91	1997	6	2.9L	B6304F		41629		41969*	0.7
Volvo	C70	Coupe	03/98	1999	5	2.3L	B5234T	Turbo	41602		41970*	0.8
Volvo	C70		07/99	2004	5	2.3L	B5234T5	Convertible Turbo	41602		41970*	0.8
Volvo	C70	Coupe	07/99	2003	5	2.3L	B5234T5	Turbo	41602		41970*	0.8
Volvo	C70	Coupe	07/99	2001	5	2.4L	B5244T	Turbo			41970*	0.7
Volvo	C70		08/99	2001	5	2.4L	B5244T	Convertible Turbo			41970*	0.7
Volvo	S40		02/97	2004	4	2.0L	B4204S	Sedan			41970*	0.7
Volvo	S40		09/97	2001	4	1.9L	B4194T	Sedan Turbo			41970*	0.7
Volvo	S40		02/98	2004	4	2.0L	B4204T	Sedan Turbo			41970*	0.7
Volvo	S40		07/99	2001	4	1.8L	B4184S	Sedan			41970*	0.7
Volvo	S40		01/01	2003	5	2.3L	B5234T	Sedan Turbo			41970*	0.7
Volvo	S40		01/01	09/09	5	2.4L	B5244S	Sedan			41970*	0.7
Volvo	S40		01/01	2003	5	2.4L	B5244T	Sedan Turbo			41970*	0.7
Volvo	S40		06/02	09/04	5	2.4L	B5244T	Sedan Turbo			41970*	0.7
Volvo	S60		03/03	09/09	5	2.5L	B5254T2		41602		41970*	0.8
Volvo	S70		1997	1998	5	2.4L	B5252S	Sedan			41970*	0.7
Volvo	S70		1997	1999	5	2.4L	B5254S	Sedan			41970*	0.7
Volvo	S70		02/97	1998	5	2.3L	B5234T	Sedan T5 Turbo			41970*	0.7
Volvo	S70		02/97	2001	5	2.4L	B5254T	Sedan Turbo			41970*	0.7
Volvo	S80		05/98	10/03	6	2.7L	B6284T	Sedan T6 Turbo	41602		41970*	0.8
Volvo	S80		05/98	2003	6	2.9L	B6304F	Sedan	41629		41969*	0.7
Volvo	S80		2003	07/05	5	2.5L	B5254T2		41602		41970*	0.8
Volvo	S90		03/97	1998	6	2.9L	B6304F	Sedan	41629		41969*	0.8
Volvo	V40		02/97	2004	4	2.0L	B4204S	Wagon			41970*	0.7
Volvo	V40		09/97	2001	4	1.9L	B4194T	Wagon T4 Turbo			41970*	0.7
Volvo	V40		02/98	2004	4	2.0L	B4204T	Wagon Turbo			41970*	0.7
Volvo	V40		07/99	2001	4	1.8L	B4184S	Wagon			41970*	0.7
Volvo	V70		02/97	2003	5	2.3L	B5234T	Wagon Turbo			41970*	0.7
Volvo	V70		02/97	10/98	5	2.4L	B5252S	Wagon			41970*	0.7
Volvo	V70		02/97	07/99	5	2.4L	B5254S	Wagon			41970*	0.7
Volvo	V70		02/97	1998	5	2.4L	B5254T	Wagon Turbo			41970*	0.7
Volvo	V70		02/97	2004	5	2.4L	B5254T	Wagon Turbo			41970*	0.7
Volvo	V70		11/97	2000	5	2.3L	B5234T	Wagon R Turbo			41970*	0.7
Volvo	V70		02/00	05/03	5	2.4L	B5244T3		41602		41970*	0.8
Volvo	V90		03/97	1998	6	2.9L	B6304F	Wagon	41602		41970*	0.8
Volvo	XC70	Cross Country	2000	2004	5	2.4L	B5244T3		41602		41970*	0.8

MAKE	MODEL	SERIES / BADGE	FROM	TO	CYLS	CAPACITY	ENGINE	ADDITIONAL INFORMATION	REGULAR	PLATINUM (RAPIDFIRE®)	DOUBLE PLATINUM	GAP (MM)#
Volvo	XC70	Cross Country	04/03	11/07	5	2.5L	B5254T2	Wagon Turbo			41970*	0.7
Volvo	XC90		07/03	02/07	5	2.5L	B5254T2	Wagon Turbo			41970*	0.7
Volvo	XC90	T6	07/03	09/06	6	2.9L	B6294T	Wagon Turbo			41970*	0.7
Volvo	XC90		02/07	07/11	8	4.4L	B8444S	Wagon	41602	AC5	41801	1.1

Spark Plug Catalogue

abbreviations

ABBREVIATION	EXPLANATION OF ABBREVIATION
AUTO	Automatic Transmission
BBL	Barrel
CARB	Carburettor
DOHC	Double Overhead Camshaft
E85	85% Ethanol Petrol Compatible
EFI	Electronic Fuel Injection
F/I	Fuel Injection
HFV6	High Feature V6 Engine
HP	Horsepower
INCL	Includes
kW	Kilowatts
LPG	Liquid Petroleum Gas
LWB	Long Wheel Base
MANUAL	Manual Transmission
MPI	Multi Point Injection
OHC	Overhead Camshaft
RWD	Rear Wheel Drive
SIDI	Spark Ignition Direct Injection
SOHC	Single Overhead Camshaft
SWB	Short Wheel Base
V	Valves
VCT	Variable Camshaft Timing
VIN	Vehicle Identification Number
VVT	Variable Valve Timing



Spark Plug Specifications

regular spark plugs

ACDelco Regular Spark Plugs (Common characteristics - J type electrode, Resistor style except for 42XLS & 43XLS which are a Non Resistor style)

Refer to Illustration Number:	1	2	3	3	4	5	6	7	8	9	10		12	13	14
ACDelco Part #	Insulator Barrel Diameter	Installed Height (mm)	Reach (mm)	Reach (")	Spark Location (mm)	Gap (mm)	Max. Side Wire Projection (mm)	Side Wire Thickness (mm)	Side Wire Width (mm)	Thread Pitch	"Hex Size (Socket Size - Inches)"	IMEP Heat Range Value (The lower the heat range the hotter the plug)	Seat Type	Terminal Type (Solid or Loose)	Insulator Profile (Ribbed or Smooth)
41602	10.24	50.50	19.05	3/4"	3.38	0.89	6.35	1.52	2.79	M14x1.25	5/8"	320	Flat	Solid	Smooth
41629	10.24	50.98	19.05	3/4"	3.38	0.89	6.35	1.52	2.79	M14x1.25	5/8"	240	Flat	Solid	Smooth
42XLS	12.29	56.49	19.05	3/4"	3.38	0.89	6.50	1.52	2.79	M14x1.25	13/16"	320	Flat	Solid	Ribbed
43XLS	12.20	56.90	19.05	3/4"	3.42	0.70	5.72	1.60	2.60	M14x1.25	13/16"	N/A	Flat	Loose	Ribbed
FR1LS	10.50	50.50	19.05	3/4"	3.38	0.89	6.35	1.52	2.79	M14x1.25	5/8"	375	Flat	Solid	Ribbed
FR2LS	10.50	50.50	19.05	3/4"	2.98	1.00	5.58	1.60	2.70	M14x1.25	5/8"	N/A	Flat	Solid	Ribbed
FR3LS	10.50	50.50	19.05	3/4"	3.00	1.00	5.30	1.30	2.50	M14x1.25	5/8"	N/A	Flat	Loose	Ribbed
R42LTS	10.50	51.46	17.25	11/16"	3.38	1.12	6.80	1.52	2.79	M14x1.25	5/8"	280	Conical	Solid	Ribbed
R42LTS6	10.50	51.46	17.25	11/16"	3.38	1.52	6.60	1.27	2.79	M14x1.25	5/8"	240	Conical	Solid	Ribbed
R42XLS	12.29	56.49	19.05	3/4"	3.38	0.89	6.50	1.52	2.79	M14x1.25	13/16"	320	Flat	Solid	Ribbed
R43XLS	12.29	56.49	19.05	3/4"	3.38	1.02	6.60	1.52	2.79	M14x1.25	13/16"	275	Flat	Solid	Ribbed
R44LTS6	10.50	51.46	17.25	11/16"	3.38	1.52	7.00	1.27	2.79	M14x1.25	5/8"	240	Conical	Solid	Ribbed
R44TS	10.90	60.25	11.00	7/16"	3.38	1.12	6.50	1.27	2.79	M14x1.25	5/8"	245	Conical	Solid	Ribbed
R44XLS	12.29	56.49	19.05	3/4"	3.38	1.02	6.35	1.27	2.79	M14x1.25	13/16"	250	Flat	Solid	Ribbed

ACDelco Regular Spark Plugs (Common characteristics - J type electrode, Resistor style)

Refer to Illustration Number:	1	2	3	3	4	5	6	7	8	9	10		12	13	14
ACDelco Part # (Euro style numbers)	Insulator Barrel Diameter	Installed Height (mm)	Reach (mm)	Reach (")	Spark Location (mm)	Gap (mm)	Max. Side Wire Projection (mm)	Side Wire Thickness (mm)	Side Wire width (mm)	Thread Pitch	"Hex Size (Socket Size - Inches)"	Heat Range (0 = cold, 9 = hot)	Seat Type	Terminal Type (Solid or Loose)	Insulator Profile (Ribbed or Smooth)
R4600	10.50	53.00	17.50	11/16"	3.00	1.10	5.73	1.60	2.70	M14x1.25	5/8"	4	Conical	Loose	Ribbed
R5602 *	10.50	50.20	19.05	3/4"	5.70	0.80	5.80	1.80	3.00	M14x1.25	5/8"	5	Flat	Solid	Smooth
R5610	10.50	50.50	19.05	3/4"	4.90	1.10	7.60	1.60	2.70	M14x1.25	5/8"	5	Flat	Solid	Ribbed
R6602	10.50	53.00	17.50	11/16"	3.00	0.90	5.50	1.60	2.70	M14x1.25	5/8"	6	Conical	Loose	Ribbed
R6606	12.20	56.90	19.05	3/4"	3.08	1.10	5.98	1.80	2.80	M14x1.25	5/8"	6	Flat	Loose	Ribbed
R8602	10.50	50.50	19.05	3/4"	4.80	1.10	7.50	1.60	2.70	M14x1.25	5/8"	8	Flat	Solid	Ribbed
R9601	12.20	56.90	19.05	3/4"	4.48	1.10	7.18	1.60	2.70	M14x1.25	13/16"	9	Flat	Loose	Ribbed

* Two electrodes



Spark Plug Specifications

platinum (rapidfire[®]) spark plugs

ACDelco Platinum Spark Plugs (Common characteristics - Resistor style, Solid Terminal type, Smooth Insulator Profile, J type electrode)

Refer to Illustration Number:	1	2	3	3	4	5	6	7	8	9	10		11	12
ACDelco Part #	Insulator Barrel Diameter (mm)	Installed Height (mm)	Reach (mm)	Reach (")	Spark Location (mm)	Gap (mm)	Max. Side Wire Projection (mm)	Side Wire Thickness (mm)	Side Wire Width (mm)	Thread Pitch	Hex size (Socket Size - Inches)	IMEP Heat Range Value (The lower the heat range the hotter the plug)	Electrode Enhancements	Seat Type
AC4	11.76	56.49	19.05	3/4"	3.38	1.02	6.47	1.52	2.79	M14x1.25	13/16"	320	Single platinum pad on the center electrode with corners of ground electrode trimmed off	Flat
AC5	10.24	50.98	19.05	3/4"	3.38	1.12	6.52	1.52	2.79	M14x1.25	5/8"	280	Single platinum pad on the center electrode with corners of ground electrode trimmed off	Flat
AC6	10.49	51.38	17.25	11/16"	4.82	1.12	7.97	1.27	2.79	M14x1.25	5/8"	240	Single platinum pad on the center electrode with corners of ground electrode trimmed off	Conical
AC8	10.49	52.71	17.25	11/16"	3.37	0.89	6.29	1.52	2.79	M14x1.25	5/8"	280	Single platinum pad on the center electrode with corners of ground electrode trimmed off	Conical
AC14	10.49	51.38	17.25	11/16"	3.37	1.52	6.93	1.27	2.79	M14x1.25	5/8"	240	Single platinum pad on the center electrode with corners of ground electrode trimmed off	Conical



Spark Plug Specifications

double platinum spark plugs

ACDelco Double Platinum Spark Plugs (Common characteristics - Resistor style, Solid Terminal type, Smooth Insulator Profile, J type electrode)														
Refer to Illustration Number:	1	2	3	3	4	5	6	7	8	9	10		11	12
ACDelco Part #	Insulator Barrel Diameter (mm)	Installed Height (mm)	Reach (mm)	Reach (")	Spark Location (mm)	Gap (mm)	Max. Side Wire Projection (mm)	Side Wire Thickness (mm)	Side Wire Width (mm)	Thread Pitch	Hex size (Socket Size - Inches)	IMEP Heat Range Value (The lower the heat range the hotter the plug)	Electrode Enhancements	Seat Type
41800	10.24	50.98	19.05	3/4"	3.38	1.12	6.60	1.52	2.79	M14x1.25	5/8"	275	Platinum pad on the center electrode with a platinum pad on the ground electrode	Flat
41801	10.24	50.98	19.05	3/4"	3.38	1.12	6.60	1.52	2.79	M14x1.25	5/8"	320	Platinum pad on the center electrode with a platinum pad on the ground electrode	Flat
41802	11.76	56.49	19.05	3/4"	3.38	1.12	6.60	1.52	2.79	M14x1.25	13/16"	275	Platinum pad on the center electrode with a platinum pad on the ground electrode	Flat
41804	11.76	56.49	19.05	3/4"	3.38	0.86	6.35	1.52	2.79	M14x1.25	13/16"	320	Platinum pad on the center electrode with a platinum pad on the ground electrode	Flat
41805	10.50	52.78	17.25	11/16"	4.83	1.37	7.90	1.27	2.79	M14x1.25	5/8"	245	Platinum pad on the center electrode with a platinum pad on the ground electrode	Conical
41806	10.24	50.98	19.05	3/4"	4.75	1.12	7.90	1.52	2.79	M14x1.25	5/8"	275	Platinum pad on the center electrode with a platinum pad on the ground electrode	Flat
41810	10.50	52.78	17.25	11/16"	3.38	1.12	6.50	1.52	2.79	M14x1.25	5/8"	280	Platinum pad on the center electrode with a platinum pad on the ground electrode	Conical
41814	10.90	49.66	24.94	1"	3.38	1.3	6.70	1.52	2.79	M14x1.25	5/8"	350	Platinum pad on the center electrode with a platinum pad on the ground electrode	Conical
41825	10.24	52.98	19.05	3/4"	3.38	1.12	6.50	1.52	2.79	M14x1.25	5/8"	320	Platinum pad on the center electrode with a platinum pad on the ground electrode	Flat
41826	10.90	62.74	10.95	7/16"	3.38	1.78	7.00	1.27	2.79	M14x1.25	5/8"	220	Platinum pad on the center electrode with a platinum pad on the ground electrode	Conical
41833	11.76	62.56	9.40	3/8"	3.45	0.86	6.10	1.27	2.54	M14x1.25	13/16"	240	Platinum pad on the center electrode with a platinum pad on the ground electrode	Flat
41942	10.49	51.38	17.25	11/16"	3.37	1.27	6.25	1.52	2.79	M14x1.25	5/8"	240	Finewire platinum center electrode with a platinum pad on the ground electrode	Conical

Spark Plug Specifications

double platinum finewire spark plugs

ACDelco Double Platinum Finewire Spark Plug (Common characteristics - Resistor style, Solid Terminal type, Smooth Insulator Profile, J type electrode)														
Refer to Illustration Number:	1	2	3	3	4	5	6	7	8	9	10		11	12
ACDelco Part #	Insulator Barrel Diameter (mm)	Installed Height (mm)	Reach (mm)	Reach (")	Spark Location (mm)	Gap (mm)	Max. Side Wire Projection (mm)	Side Wire Thickness (mm)	Side Wire Width (mm)	Thread Pitch	Hex size (Socket Size - Inches)	IMEP Heat Range Value (The lower the heat range the hotter the plug)	Electrode Enhancements	Seat Type
41834	10.50	55.68	25.00	1"	3.38	1.27	6.17	1.52	2.79	M14x1.25	5/8"	340	Finewire platinum center electrode with a platinum pad on the ground electrode	Conical
41835	10.24	50.95	25.00	1"	3.38	1.12	6.02	1.52	2.79	M14x1.25	5/8"	320	Finewire platinum center electrode with a platinum pad on the ground electrode	Flat
41963	10.49	52.79	17.25	11/16"	3.37	1.27	6.75	1.27	2.79	M14x1.25	5/8"	280	Finewire platinum center electrode with a platinum pad on the ground electrode	Conical
41964	8.99	51.35	26.50	1 & 1/16"	3.81	1.02	6.67	1.27	2.54	M12x1.25	9/16"	320	Finewire platinum center electrode with a platinum pad on the ground electrode	Flat



Spark Plug Specifications

illustration

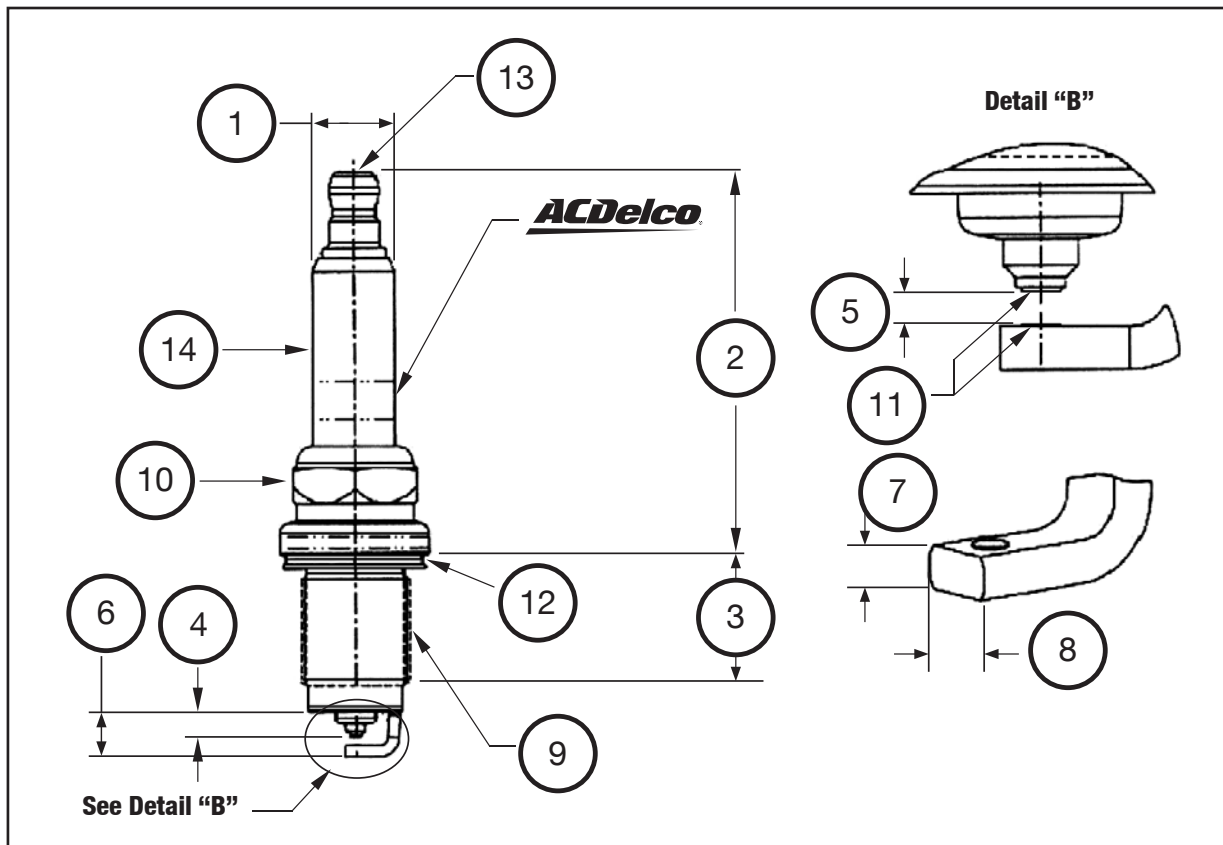

1	2	3	3	4	5	6	7	8	9	10	11	12	13	14
Insulator Barrel Diameter (mm)	Installed Height (mm)	Reach (mm)	Reach (")	Spark Location (mm)	Gap (mm)	Max. Side Wire Projection (mm)	Side Wire Thickness (mm)	Side Wire Width (mm)	Thread Pitch	Hex Size (Socket Size - Inches)	Electrode Enhancements	Seat Type	Terminal Type (Solid or Loose)	Insulator Profile (Ribbed or Smooth)

Spark Plug Specifications

metric / imperial gap conversion table

mm	0.4	0.5	0.6	0.7	0.8	0.9	1.0	1.1	1.2	1.3	1.4	1.5	1.6	2.0
↑ ↓	↑ ↓	↑ ↓	↑ ↓	↑ ↓	↑ ↓	↑ ↓	↑ ↓	↑ ↓	↑ ↓	↑ ↓	↑ ↓	↑ ↓	↑ ↓	↑ ↓
inches	.016	.020	.024	.028	.032	.036	.040	.044	.048	.052	.056	.060	.064	.080

ACDelco

ACDelco online product catalogue

Find the latest application data specific to your vehicle by using the ACDelco Online Catalogue.
Visit acdelco.com.au today to learn more.

ACDelco

Welcome to the ACDelco Online Product Catalogue.

Included in Online Catalogue

Filters

Batteries

Spark Plugs

Brake Pads

Disc Rotors

Search our online catalogue of ACDelco Filters, Batteries, Spark Plugs, Brake Pads and Disc Rotors to suit your vehicle.

Not included in Online Catalogue

- Chemicals
- Fuel Pumps
- Oils & Fluids
- Reman Cycliner Head Kits
- Reman Engines
- Steering Racks, Pumps & Boxes
- Wiper Blades & Refills

Click on the product name above to view PDF catalogues of all other ACDelco products.

Terms & Conditions

Information in this online catalogue has been compiled from data published from Original Equipment Manufacturers and other parties. This data may change from time to time and ACDelco is unable to warrant the accuracy of this data and does not accept responsibility for loss or damage of any kind caused as a result of such data being inaccurate.

Agree and launch online catalogue

NEWS | [PRIVACY STATEMENT](#)
ACDelco

Online Product Catalogue

ACDelco Automotive Parts - Vehicle Applications.
Select your desired vehicle specifications below to display a list of appropriate ACDelco Automotive Parts applications.

SELECT YOUR VEHICLE HERE

Make	Model	Year	Series	Chassis	Engine	Details
- Popular Makes	CAPRICE	ALL	SHOW ALL		2597 cc, LFX V6 24v DOHC VVT Direct Inj (190KW)	09/10-13, 4D Sedan, RWD, AT/MT, 6G1E#555
TOYOTA	CAPTIVA	2013	VE	VE	3565 cc, LFX V6 24v DOHC VVT Direct Inj (210KW)	09/10-13, BERLINA, 4D Sedan, RWD, AT/MT, 6G1E#5
HOLDEN	COLORADO	2012			3565 cc, LLT V6 24v DOHC VVT Direct Inj (210KW)	09/10-13, BERLINA, 4D Wagon, RWD, AT/MT, 6G1E#5
FORD	COMMODORE	2011			3565 cc, LY7 (H7) V6 24v DOHC VVT MPFI (190KW)	09/10-13, 4D Wagon, RWD, AT/MT, 6G1E#8E5
MITSUBISHI	COMMODORE PO	2010			3565 cc, PETROL/LPG, LY7 (H8) V6 24v DOHC VVT M	09/10-13, 2D Util, RWD, AT/MT, 6G1E#4E5
NISSAN	COMMODORE PO	2009			3565 cc, LPG, LY7 (H8) V6 24v DOHC VVT MPFI (175)	
MAZDA	CREWMAN	2008			5967 cc, L77 (AFM) V8 16v OHV MPFI (260KW)	
HONDA	CREWMAN	2007			5967 cc, L77 V8 16v OHV MPFI (270KW)	
HYUNDAI	Sub Model	2006				
SUBARU	ALL	2005				
- All Makes -	ALL	2004				
ADARTH	BERLINA	2003				
ALFA ROMEO	BERLINA LPG	2002				
ASIA	BERLINA LPG	2001				
ASTON MARTIN	EXECUTIVE	2000				
AUDI	EXECUTIVE LPG	2000				
...	GROUP A	1999				

Vehicle: HOLDEN COMMODORE Chassis: VE Vin: 6G1E#6E5

Part Number	Description	Quantity	Notes
ACF153	ACD		
ACG24	ACD		
ACD1765	ACD		
ACDR2026	ACD	2 req	
ACD1766	ACD		
ACDR2027	ACD	2 req	
41834	ACD		Double Platinum, Set Gap to [1.1]
S6638WC	ACD		

Part Number: 41834

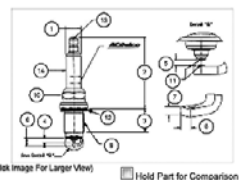

(Click Image For Larger View) Hold Part for Comparison

Description	Dimension
(1) Insulator Barrel Diameter	10.5
(2) Installed Height (mm)	55.68
(3) Reach (mm)	25
(3) Reach (inch)	1
(4) Spark Location (mm)	3.38
(5) Gap (mm)	1.27

NEWS | [PRIVACY STATEMENT](#) | [SITE-MAP](#) | [ACDelco WORLDWIDE](#)



A word about this catalogue. We have tried to make this catalogue as comprehensive and factual as possible. However, since the time of printing some of the information you'll find here may have been updated. Also, some of the equipment shown or described through this catalogue may have been changed. Further, GM Holden Ltd ABN 84 006 893 232, reserves the right to make changes at any time without notice. No Holden Dealer or other person is authorised or permitted to give or make any statement, assertion or undertaking in relation to the quality, performance characteristics, descriptions or fitness for any purpose of any ACDelco product which is at variance with any written statement, assertion or undertaking on any of these subjects given or made by Holden in its published sales literature, and Holden does not accept any liability for any such unauthorised action.

Holden has authorised Dealers in many parts of Australia for the sale of service parts and the provision of service to owners of Holden's products. Every endeavour is made to ensure that such Dealers carry adequate stocks of service parts, but Holden doesn't make any promise other than that contained in the New Vehicle Warranty given by Holden that such parts or service facilities will be available at any specific location or at any particular time.

Express warranties offered for ACDelco products are subject to the conditions set out in all vehicle handbooks. Details also available from Holden on request. Copyright Holden. April 2018

Available from:

1800 ACDelco
acdelco.com.au

ACDelco